



GLOBAL MANUFACTURING & DISTRIBUTION

WELCOME

An Introduction to the Perry Group

The Perry Group was founded in 1925 as a leading European manufacturer of Ironmongery and Gate Hardware. 96 years later, UKANDIN was formed in 2021 in Delhi, India. It is now the Perry Group's purpose-built manufacturing facility, established to take full control of the supply chain.

The facility has enabled the group to have direct control of quality and production of all products, as well as extensively develop new ranges and produce custom order requirements for customers within the UK, Europe and across the world.

WHAT WE DO

UKANDIN are a Manufacturing Export Company based in Greater Noida, India with over 50,000 sq feet of warehousing and manufacturing capacity, focusing on ironmongery and agricultural hardware products. Our additional European Group Manufacturing and Distribution Facility offers a further 140,000 sq feet in the United Kingdom.

Offering competitive pricing with market leading quality and service, our extensive toolroom enables us to develop bespoke products, supplying to customers exact requirements - including those outside of our traditional agricultural industries.

PRESSED STEEL
& ALUMINIUM



FORGED STEEL
& BRASS



CASTING



THREAD ROLLING



WIRE FORMING



INJECTION
MOULDING



FINISHING



LASER CUTTING



MOST COMMON FINISHES



Key to Corrosion resistance



Galvanised: (GV)

Galvanising is a rough grey finish commonly known as Hot Dipped or Hot Spelter Galvanised. The galvanising process creates a protective zinc layer, offering exceptional corrosion resistance and longevity.

UKANDIN galvanising is industry leading with up to 60% thicker microns to other leading brands, making it the superior finish on the UK market.



Corrosion Resistance: Excellent corrosion resistance, making it ideal for rugged outdoor conditions.



Self Colour: (SC)

Self Colour means the product is uncoated and has a natural, raw appearance. This finish is often used to paint over the product.



Corrosion Resistance: No corrosion resistance; best suited for dry indoor environments.



Black Powder Coated (BK)

Black Powder Coated finishes are suited for both indoor and outdoor use. Providing a sleek, matte black appearance. This finish offers standard durability and resistance to weathering, making it a popular choice for gates, fences, and more.



Corrosion Resistance: Moderate corrosion resistance, suitable for general use, but not ideal for harsh outdoor conditions.



Zinc Plated: (ZP)

Zinc Plated hardware is versatile and suitable for a wide range of applications as it provides a moderate protective layer against corrosion, enhancing the longevity of the item.



Corrosion Resistance: Moderate corrosion resistance; suitable for general use, but not ideal for harsh outdoor conditions.

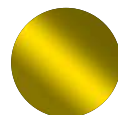

Yellow Passivated: (YP)

Produced using the same process as silver coloured zinc plating but with a yellow tint. It is versatile and suitable for a wide range of applications as it provides a protective layer against corrosion, enhancing the longevity of the item.



Corrosion Resistance: Moderate corrosion resistance; suitable for general use, but not ideal for harsh outdoor conditions.



Stainless Steel: (SS)

Stainless Steel is a premium and attractive silver finish, suitable for a wide variety of outdoor applications, where extreme weather resistance is needed.



Corrosion Resistance: Excellent corrosion resistance, suitable for all environments, including marine and corrosive settings.



Pre-Galvanised: (PG)

General Use: Pre-Galvanised items are used in construction and structural applications, offering corrosion protection.



Corrosion Resistance: Good corrosion resistance, suitable for many outdoor uses.

AGRICULTURAL

Pages 3 - 26



*ARCHITECTURAL
IRONMONGERY*

Pages 77 - 106



GATE & SHED

Pages 27 - 48



*WIRE FORMED
PRODUCTS*

Pages 107 - 110



*FENCING &
LANDSCAPE*

Pages 49 - 64



*PACKAGING
OPTIONS*

Page 111



*DOMESTIC &
INTERNAL*

Pages 65 - 76



*BESPOKE LASER
CUTTING*

Page 112





AGRICULTURAL

Metal Fieldgates & Accessories	4	Metal Feeders	20
Sheep Hurdles	9	Trailer Fittings	22
Wooden Fieldgate Sets	10	Stable & Paddock	24
Wooden Fieldgate Accessories	12		



Bespoke Designs Available



No.2153

Metal Fieldgates with Box End - 7 Rail

Constructed with precision from robust, galvanised steel, these gates offer unparalleled strength and resilience. The sleek design and sturdy structure ensure long-lasting performance.

- Top and bottom rails - 43mm tube
- Intermediate rails - 29mm tube
- Fastens using a Sprung Slide Bolt (sold separately, No.178, see page 9)
- Gate hangs on Adjustable gate eyes (sold separately, No.165, see page 19)
- 50mm x 50mm SHS (Square Hollow Section) sleeved hanging stile

Code	Size	Finish
2153-0900GV	3ft - 914mm x 1150mm x 50mm	Galv'd
2153-1200GV	4ft - 1219mm x 1150mm x 50mm	Galv'd
2153-1500GV	5ft - 1524mm x 1150mm x 50mm	Galv'd
2153-1800GV	6ft - 1829mm x 1150mm x 50mm	Galv'd
2153-2400GV	8ft - 2438mm x 1150mm x 50mm	Galv'd
2153-3000GV	10ft - 3048mm x 1150mm x 50mm	Galv'd
2153-3600GV	12ft - 3658mm x 1150mm x 50mm	Galv'd
2153-4200GV	14ft - 4267mm x 1150mm x 50mm	Galv'd
2153-4500GV	15ft - 4572mm x 1150mm x 50mm	Galv'd
2153-4800GV	16ft - 4876mm x 1150mm x 50mm	Galv'd



No.2152

Metal Fieldgates with Channel End - 7 Rail

Constructed with precision from robust, galvanised steel, these gates offer unparalleled strength and resilience. The sleek design and sturdy structure ensure long-lasting performance. The channel on the end allows vertical adjustment of the gate.

- 4.5mm thick material for the channel end
- Top and bottom rails - 43mm tube
- Intermediate rails - 29mm tube
- Fastens using a No.2152FX
- 50mm x 50mm SHS (Square Hollow Section) sleeved hanging stile

Code	Size	Finish
2152-3000GV	10ft - 3048mm x 1150mm x 50mm	Galv'd
2152-3600GV	12ft - 3658mm x 1150mm x 50mm	Galv'd
2152-4500GV	15ft - 4572mm x 1150mm x 50mm	Galv'd

No.2156

Round Hanging Post

With a diameter of 114mm and a length of 2m, this post provides ample strength. Equipped with 19mm hooks.

- Compatible with No.2152 & No.2153 gates
- 114mm Diameter x 2m Long
- 19mm Hooks

Code	Size	Finish
2156-0114GV	114mm	Galv'd



No.2157

Round Receiving Post

A versatile and practical solution with a diameter of 114mm and a length of 2m

- Compatible with No.2152 & No.2153 gates
- 114mm Diameter x 2m Long
- Slot cut into one side to receive a bolt

Code	Size	Finish
2157-0000GV	114mm	Galv'd



No.178

Sprung Slide Bolts for Metal Gates

Traditional type Slide Bolt to suit metal gates.

- Pin loose with washer in the bag
- Galvanised for maximum protection

Code	Size	Finish	Box Qty	Ctn Qty
178-0300GV	300mm 12"	Galv'd	-	10



No.2152FX

Channel Gate Fixing Kit

A fixing kit designed to hang No.2152 gates. To be used with 19mm hooks.

- 2 x 100mm No.165 Adjustable Gate Eyes + 19mm Eye
- 1 x 300mm No.178 Sprung Slide Bolts

Code	Finish	Ctn Qty
2152FX0000GV	Galv'd	10

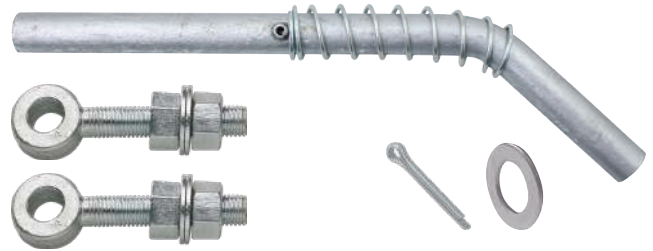

No.2153FX

Box Gate Fixing Kit

A fixing kit designed to hang No.2153 gates. To be used with 19mm hooks.

- 2 x 150mm No.165 Adjustable Gate Eyes + 19mm Eye
- 1 x 300mm No.178 Sprung Slide Bolts

Code	Finish	Ctn Qty
2153FX0000GV	Galv'd	10

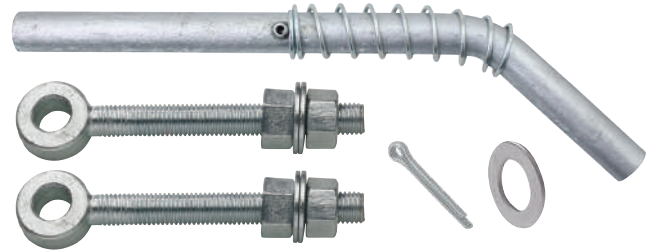

No.2158

Square Ground Sockets with Removable Cap

Designed for secure installation of 100mm x 100mm (4" x 4") square posts.

- 114mm x 457mm (18")
- Suits 100mm x 100mm (4" x 4") square posts
- Steel cap to close off the socket when not in use

Code	Size	Finish
2158-0000GV	-	Galv'd

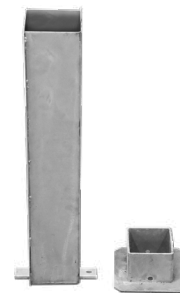

STEEL FENCING SYSTEM AVAILABLE

EXCLUSIVE

Designed as a cost effective, long lasting solution for livestock fencing

See Page 64





No.154R

Gate Hooks to Weld with Radius End Base

For welding onto curved metal surface.

- Natural self colour allows own coating

Code	Size	Finish	Box Qty	Ctn Qty
154R0019SC	19mm	Self Colour	10	30



No.154S

Gate Hooks to Weld with Straight End Base

For welding onto flat metal surface.

- Natural self colour allows own coating

Code	Size	Finish	Box Qty	Ctn Qty
154S0012SC	12mm	Self Colour	10	100
154S0016SC	16mm	Self Colour	10	40
154S0019SC	19mm	Self Colour	10	30
154S0022SC	22mm	Self Colour	10	30
154S0025SC	25mm	Self Colour	-	10
154S0032SC	32mm	Self Colour	-	10



No.155R

Gate Eyes to Weld with Radius End Base

For welding onto curved metal surface.

- Natural self colour allows own coating

Code	Size	Finish	Box Qty	Ctn Qty
155R0019SC	19mm	Self Colour	10	60



No.155S

Gate Eyes to Weld with Straight End Base

For welding onto flat metal surface.

- Natural self colour allows own coating

Code	Size	Finish	Box Qty	Ctn Qty
155S0012SC	12mm	Self Colour	10	150
155S0016SC	16mm	Self Colour	10	60
155S0019SC	19mm	Self Colour	10	60
155S0022SC	22mm	Self Colour	10	60
155S0025SC	25mm	Self Colour	-	10
155S0032SC	32mm	Self Colour	-	10

No.435

Hooks on 50mm Oblong (50mm 2") Plates

Heavy duty hook designed for a gate eye.

- Enables gate to be lifted on or off for maintenance purposes
- Galvanised for maximum protection

Code	Size	Finish	Box Qty	Ctn Qty
435-0019GV	19mm	Galv'd	-	5

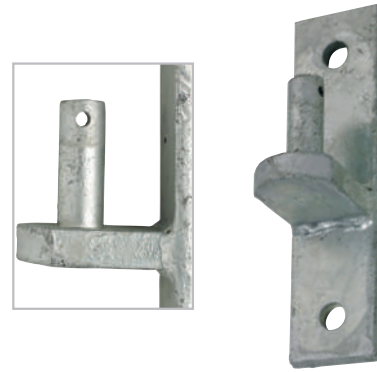

No.194

Adjustable RSJ Gate Hanger for Metal Gates

Used for hanging gates off RSJ (Rolled Steel Joists).

- To suit 4" to 7" RSJ
- Galvanised for maximum protection

Code	Size	Finish	Box Qty	Ctn Qty
194-0019GV	19mm 3/4"	Galv'd	1	10



No.191

Adjustable Gate Eye Set for Metal Gates

For use with metal tubular gates

Code	Size	Finish	Box Qty	Ctn Qty
191-0019ZP	19mm 3/4" x 90mm	BZP-E/Galv	-	10
191-0022ZP	22mm 7/8" x 90mm	BZP-E/Galv	-	10



No.184

Flat Plat - Concrete in Gate Stop

Gate stop - concrete in.

- Galvanised for maximum protection

Code	Size	Finish	Box Qty	Ctn Qty
184-0200GV	200mm x 120mm	Galv'd	-	10



No.183

Centre Gate Stop with 3 Legs

- Galvanised for maximum protection

Code	Size	Finish	Box Qty	Ctn Qty
183-0120GV	120mm	Galv'd	5	20



AGRICULTURAL

GATE & SHED

FENCING & LANDSCAPING

DOMESTIC & INTERNAL

ARCHITECTURAL IRONMONGERY

WIRE FORMED PRODUCTS

PACKAGING OPTIONS

BESPOKE LASER CUTTING



No.153

Flat Sided Metal Gate Throw

Flat sided throw over for closing metal gates.

- Galvanised for maximum protection

Code	Size	Finish	Box Qty	Ctn Qty
153-0750GV	750mm 30"	Galv'd	-	5



No.158

Throw Over Loops Non-Lockable

Non-lockable throw over for closing metal gates.

- Galvanised for maximum protection

Code	Size	Finish	Box Qty	Ctn Qty
158-0350GV	350mm 14"	Galv'd	-	2



No.158L

Throw Over Loops Lockable

Lockable throw over for closing metal gates.

- Galvanised for maximum protection

Code	Size	Finish	Box Qty	Ctn Qty
158L-0860GV	860mm 34"	Galv'd	-	2

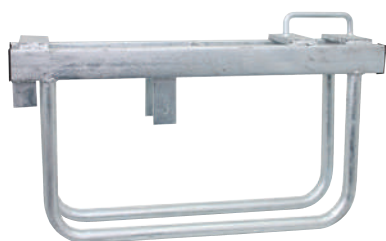

No.159

Throw Over Loop Lift 'N' Slide

Lift & slide mechanism. Throw over or closing metal gates.

- Galvanised for maximum protection

Code	Size	Finish	Box Qty	Ctn Qty
159-0660GV	660mm 26"	Galv'd	-	2



No.258

Drop Bolt for Metal Gate (Bolt on Type)

Bolt on Drop Bolt to suit metal gates.

- Galvanised for maximum protection

Code	Size	Finish	Box Qty	Ctn Qty
258-0560GV	560mm 22"	Galv'd	-	5



No.253

Heavy Duty 7 Rail Sheep Hurdle

Available in 6ft, 5ft or 4ft varieties, our 7 rail interlocking Sheep Hurdles are vital piece of farming equipment, creating an effective and animal friendly pen for sheep and lambs.

- Stronger and more cost-effective than wooden alternatives
- Lightweight and easy to handle
- Fully welded round tube horizontals to add strength and longevity
- Interlocking for stability
- 7 rails for strength
- Hot dip galvanised for a maintenance free life

Code	Size	Finish	Box Qty	PLT Qty
253-1200GV	4ft	Galv'd	-	45
253-1500GV	5ft	Galv'd	-	45
253-1800GV	6ft	Galv'd	-	45

For alternate quantities talk to your account manager or contact sales

Bespoke Designs Available



Larger Loops for easier connection and multi-adjust angle runs



No.2163

Heavy Duty 7 Rail Lugged Sheep Hurdle

Available in 6ft, 5ft or 4ft varieties, our 7 rail lugged Sheep Hurdles are vital piece of farming equipment, creating an effective and animal friendly pen for sheep and lambs.

- Supplied with No.2163 12mm Drop Pin
- Stronger and more cost-effective than wooden alternatives
- Lightweight and easy to handle
- Fully welded round tube horizontals to add strength and longevity
- 7 rails for strength
- Hot dip galvanised for a maintenance free life

Code	Size	Finish	Box Qty	PLT Qty
2163-1200GV	4ft	Galv'd	-	45
2163-1500GV	5ft	Galv'd	-	45
2163-1800GV	6ft	Galv'd	-	45

For alternate quantities talk to your account manager or contact sales

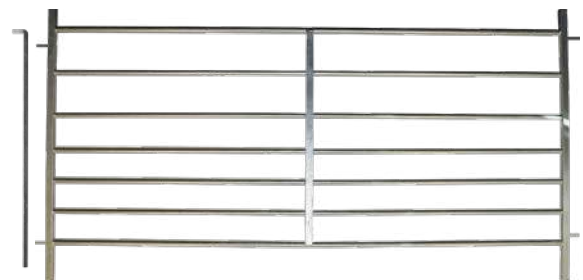

Also available on its own

No.2163P

Spare Drop Pin
2163P0012GV

Easily connected using provided 12mm drop pin



UKANDIN IN HOUSE MANUFACTURING CAPABILITY

Pressed Steel & Aluminium • Forged Steel & Brass
Casting • Thread Rolling • Wire Forming
Injection Moulding • Finishing • Laser Cutting





Contents:
1 x Spring Latch, 1 x Keep, 1 x Fabricated Staple Catch, Supplied with fittings

No.132/PP

Fieldgate Spring Fastener Sets

Suitable for most timber field gates.
• Made to suit 3" gates

3"
(75mm)
Gates

Code	Size	Finish	Box Qty	Ctn Qty
132-PP0000GV	-	Galv'd	1	8



No.259/PP

Prepacked Double Gate Fastener Sets

Secures joining points of gates together. For 3" gates.
• 1 x 18" No.260 Garage Door Drop Bolt
• 1 x No.588 Tubular Receiver & Square Plate Receiver
• 1 x 14" No.156M Medium Throw Over Loop
• Supplied with fittings

Code	Size	Finish	Box Qty	Ctn Qty
259-PP0350GV	350mm 14"	Galv'd	1	5



No.132SL

Spring Fastener Spring Latch

• Galvanised for maximum protection

Code	Size	Finish	Box Qty	Ctn Qty
132-SL--GV	-	Galv'd	-	10



No.132DC

Solid Spring Fastener Drive Catch

• Galvanised for maximum protection

Code	Size	Finish	Box Qty	Ctn Qty
132-DC--GV	-	Galv'd	-	10



No.132FS

Spring Fastener Fabricated Staple Catch

• Galvanised for maximum protection

Code	Size	Finish	Box Qty	Ctn Qty
132-FS--GV	-	Galv'd	-	10



No.149

Reversible Central Closing Gate Catches

Reversible catch for left, right, inward or outward opening gates and doors.
• Bolted onto surface
• Galvanised for maximum protection

Code	Size	Finish	Box Qty	Ctn Qty
149-0000GV	150mm 6"	Galv'd	-	10

No.167-153/PP

Adjustable Bottom Fieldgate Hinge Sets with 4" x 4" Plates

Suitable for most timber field gates.

• For 3" (75mm) gates

Code	Size	Finish	Box Qty	Ctn Qty
167-153PPSET1GV	600mm 24"	Galv'd	-	2
167-153PPSET2GV	450mm 18"	Galv'd	-	2
167-153PPSET3GV	300mm 12"	Galv'd	-	2

Contents: 1 x Top Band, 1 x Adjustable Bottom Gate Fitting, 2 x No.153 Hook on 4" x 4" Plates, Supplied with fittings

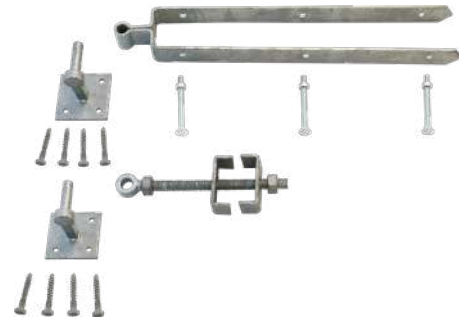

No.131-153/PP

Fieldgate Hinge Sets on 4" x 4" Plates

Suitable for most timber field gates.

• For 3" (75mm) gates

Code	Size	Finish	Box Qty	Ctn Qty
131-153PPSET1GV	600mm 24"	Galv'd	-	2
131-153PPSET2GV	450mm 18"	Galv'd	-	2
131-153PPSET3GV	300mm 12"	Galv'd	-	2

Contents: 1 x Top Band, 1 x Bottom Band, 2 x No.153 Hook on 4" x 4" Plates, Supplied with fittings

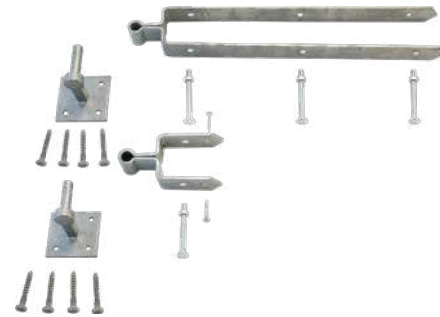

No.131H/PP

Heavy Fieldgate Hinge Sets

Suitable for most timber field gates.

• For 3" (75mm) gates

Code	Size	Finish	Box Qty	Ctn Qty
131HPPSET3GV	600mm 24"	Galv'd	-	2
131HPPSET2GV	450mm 18"	Galv'd	-	2
131HPPSET1GV	300mm 12"	Galv'd	-	2

Contents: 1 x Top Band, 1 x 5" Bottom Band, 1 x 19mm dia. 13" Hook to Bolt, 1 x 19mm dia. Hook to Drive, Supplied with fittings



No.167/PP

Adjustable Bottom Fieldgate Hinge Sets

Suitable for most timber field gates.

• For 3" (75mm) gates

• To suit 19mm diameter pins

Code	Size	Finish	Box Qty	Ctn Qty
167-PPSET1GV	600mm 24"	Galv'd	-	2
167-PPSET2GV	450mm 18"	Galv'd	-	2
167-PPSET3GV	300mm 12"	Galv'd	-	2

Contents: 1 x Top Band, 1 x Adjustable Bottom Gate Fitting, 1 x 13" Hook to Bolt, 1 x Hook to Drive, Supplied with fittings

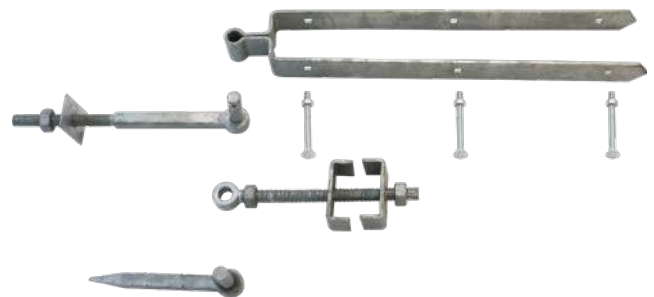

AGRICULTURAL

GATE & SHED

FENCING & LANDSCAPING

DOMESTIC & INTERNAL

ARCHITECTURAL IRONMONGERY

WIRE FORMED PRODUCTS

PACKAGING OPTIONS

BESPOKE LASER CUTTING

AGRICULTURAL

GATE & SHED

FENCING & LANDSCAPING

DOMESTIC & INTERNAL

ARCHITECTURAL IRONMONGERY

WIRE FORMED PRODUCTS

PACKAGING OPTIONS

BESPOKE LASER CUTTING



No.131HT

Heavy Fieldgate Hinge Top Band

19mm eye to suit 75mm 3" gates.

3" (75mm) Gates

Code	Size	Finish	Box Qty	Ctn Qty
131H6006BK	600mm 24"	Black	-	5
131H3006GV	300mm 12"	Galv'd	-	10
131H4506GV	450mm 18"	Galv'd	-	5
131H6006GV19	600mm 24"	Galv'd	-	5



No.131HB

Heavy Fieldgate Bottom Band

To suit 75mm 3" gates.

3" (75mm) Gates

Code	Size	Finish	Box Qty	Ctn Qty
131H1256BK19	125mm 5"	Black	-	10
131H0906GV19	90mm 3 1/2"	Galv'd	-	10
131H1256GV19	125mm 5"	Galv'd	-	10

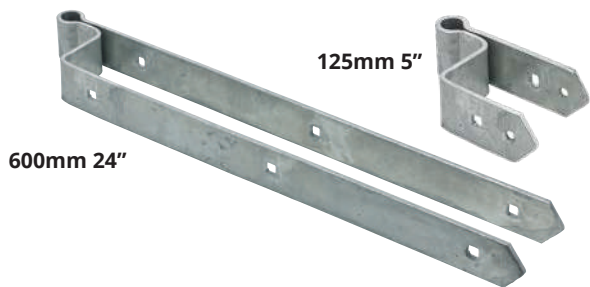

No.131SE

Fieldgate Bands with Straight Eye

The eye on this strap allows the gate to open wider.

- Allows gate to be opened a full 180 degrees
- Galvanised for maximum protection

3" (75mm) Gates

Code	Size	Finish	Box Qty	Ctn Qty
131SE125GV	125mm 5"	Galv'd	-	10
131SE600GV	600mm 24"	Galv'd	-	5



No.138

Fieldgate Hooks to Screw - 19mm Pin

Fieldgate bottom hook designed to provide maximum adjustment when fitted, also assisting gate closing ability.

- Galvanised for maximum protection
- 230mm long

Code	Size	Finish	Box Qty	Ctn Qty
138-0019GV	19mm	Galv'd	-	10



No.144B

Hooks to Build

Designed for use in brick piers and cementing into masonry.

- Galvanised for maximum protection
- To suit 9" brick work

Code	Size	Finish	Box Qty	Ctn Qty
144B0019GV	19mm	Galv'd	-	5



CERTIFIED QUALITY



No.131B

Standard 13" Fieldgate Hooks to Bolt - 19mm Pin

Heavy duty, ideal for timber posts.

- Overall length is 325mm (13") to suit 8" to 9" posts
- Fitted with one square washer and one hexagonal nut

Code	Size	Finish	Box Qty	Ctn Qty
131B0019BK	19mm	Black	-	10
131B0019GV	19mm	Galv'd	-	10
131B0022GV	22mm	Galv'd	-	10

No.131B/11

Standard 11" Fieldgate Hooks to Bolt - 19mm Pin

Heavy duty, ideal for timber posts.

- Overall length is 280mm (11") to suit 6" to 7" posts
- Fitted with one square washer and one hexagonal nut

Code	Size	Finish	Box Qty	Ctn Qty
131B0019GV11	19mm	Galv'd	-	10
131B0022GV11	22mm	Galv'd	-	10

No.131B/085

Standard 8.5" Fieldgate Hooks to Bolt - 19mm Pin

Heavy duty, ideal for timber posts.

- Overall length is 216mm (8.5") to suit 4" to 5" posts
- Fitted with one square washer and one hexagonal nut

Code	Size	Finish	Box Qty	Ctn Qty
131B0019GV085	19mm	Galv'd	-	10

No.825

Gate Hooks to Bolt c/w Welded Washer 19mm Pin

Excellent for timber and concrete posts.

- Comes with welded washer
- Galvanised for maximum protection

Code	Size	To Suit	Finish	Box Qty	Ctn Qty
825-0200GV	200mm 8"	4" Post	Galv'd	-	10
825-0250GV	250mm 10"	6" Post	Galv'd	-	10
825-0300GV	300mm 12"	8" Post	Galv'd	-	10
825-0350GV	350mm 14"	10" Post	Galv'd	-	10
825-0400GV	400mm 16"	12" Post	Galv'd	-	10
825-0450GV	450mm 18"	14" Post	Galv'd	-	5

No.131D

Fieldgate Hooks to Drive

Heavy design for knocking into post.

- Barbed to prevent removal from post
- Cotter pin hole for additional security
- Overall length 200mm

Code	Size	Finish	Box Qty	Ctn Qty
131D0019BK	19mm	Black	-	10
131D0019GV	19mm	Galv'd	-	10



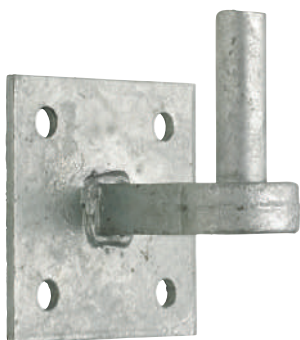

No.153EX

Hook on 4" x 4" Plate with Extended Shoulder

Heavy duty hook on plate to suit field gate double strap bands.

- Enables gate to be lifted on or off for maintenance purposes

Code	Size	Finish	Box Qty	Ctn Qty
153EX019BK	19mm	Black	-	10
153EX022BK	22mm	Black	-	10
153EX019GV	19mm	Galv'd	-	10
153EX022GV	22mm	Galv'd	-	10

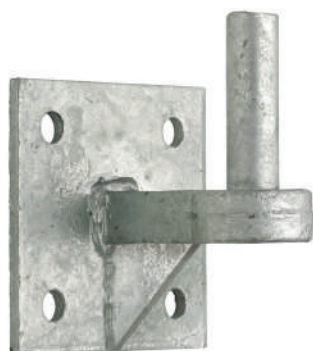
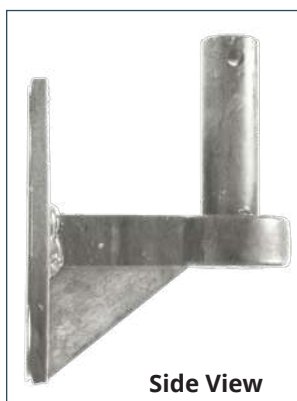

No.153EX/HD

Hook on 4" x 4" Plate with Extended Shoulder with Gusset

Heavy duty hook on plate to suit field gate double strap bands.

- Enables gate to be lifted on or off for maintenance purposes
- Gusset allows for additional support

Code	Size	Finish	Box Qty	Ctn Qty
153EXHD019GV	19mm	Galv'd	-	10
153EXHD022GV	22mm	Galv'd	-	10

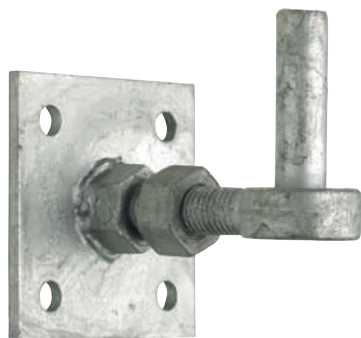

No.112F

Adjustable Hook on 4" x 4" Plates

Design allows adjustment at fitting or later if gate sag/movement occurs.

- Galvanised for maximum protection

Code	Size	Finish	Box Qty	Ctn Qty
112F000GV	19mm	Galv'd	-	10

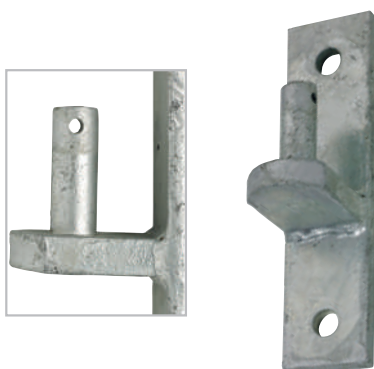

No.435

Hooks on 50mm Oblong (50mm 2") Plates

Heavy duty hook designed for a gate eye.

- Enables gate to be lifted on or off for maintenance purposes
- Galvanised for maximum protection

Code	Size	Finish	Box Qty	Ctn Qty
435-0019GV	19mm	Galv'd	-	5

No.165

Adjustable Gate Eyes

The ideal solution when placing and positioning hanging gates.

- To suit 10mm to 32mm pin

Code	Size	To Suit Pin	Finish	Box Qty	Ctn Qty
165-0100ZP10	100mm 4"	10mm	BZP-E/Galv	10	100
165-0100ZP12	100mm 4"	12mm	BZP-E/Galv	10	80
165-0100ZP16	100mm 4"	16mm	BZP-E/Galv	10	40
165-0100ZP	100mm 4"	19mm	BZP-E/Galv	-	10
165-0100ZP22	100mm 4"	22mm	BZP-E/Galv	-	10
165-0150ZP12	150mm 6"	12mm	BZP-E/Galv	10	80
165-0150ZP16	150mm 6"	16mm	BZP-E/Galv	10	40
165-0150ZP	150mm 6"	19mm	BZP-E/Galv	-	10
165-0150ZP22	150mm 6"	22mm	BZP-E/Galv	-	10
165-0200ZP16	200mm 8"	16mm	BZP-E/Galv	-	10
165-0200ZP	200mm 8"	19mm	BZP-E/Galv	-	10
165-0200ZP22	200mm 8"	22mm	BZP-E/Galv	-	10
165-0250ZP	250mm 10"	19mm	BZP-E/Galv	-	10
165-0250ZP22	250mm 10"	22mm	BZP-E/Galv	-	10
165-0150GV	150mm 6"	19mm	Galv'd	-	10
165-0150GV22	150mm 6"	22mm	Galv'd	-	10
165-0150GV25	150mm 6"	25mm	Galv'd	-	10
165-0200GV25	200mm 8"	25mm	Galv'd	-	10
165-0200GV32	200mm 8"	32mm	Galv'd	-	5



No.112E

Precision Eyebolts

Excellent when accuracy is required when placing and positioning hanging gates.

- Complete with Nuts and Washers
- 19mm Eye

Code	Size	Finish	Box Qty	Ctn Qty
112E0150ZP	150mm 6"	BZP-E/Galv	-	10
112E0200ZP	200mm 8"	BZP-E/Galv	-	10
112E0250ZP	250mm 10"	BZP-E/Galv	-	10

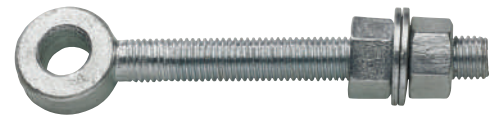

No.167AB

Adjustable Bottom Gate Fittings

Used at the base of gate hinge side for placing and positioning hanging gates.

- 2 x Full Nuts. 1 x 1/2 Nut

Code	Size	To Suit Pin	Finish	Box Qty	Ctn Qty
167AB000ZP	250mm 10"	19mm	BZP-E/Galv	-	10

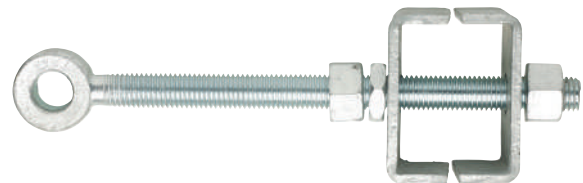

UKANDIN IN HOUSE MANUFACTURING CAPABILITY

Pressed Steel & Aluminium • Forged Steel & Brass
 Casting • Thread Rolling • Wire Forming
 Injection Moulding • Finishing • Laser Cutting





No.156S

Small Throw Over Loops

Secures joining points of gates together.

- For 3" gates

Code	Size	Finish	Box Qty	Ctn Qty
156S0150GV	150mm 6"	Galv'd	-	10

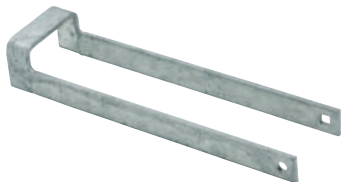

No.156M

Medium Throw Over Loops

Secures joining points of gates together.

- For 3" gates
- Also available in PerryPack

Code	Size	Finish	Box Qty	Ctn Qty
156M0350GV	350mm 14"	Galv'd	-	10



No.156N

Narrow Pattern Throw Over Loops for 2" Gates

Secures joining points of gates together.

- For 2" gates

Code	Size	Finish	Box Qty	Ctn Qty
156N0300GV	300mm 12"	Galv'd	-	10

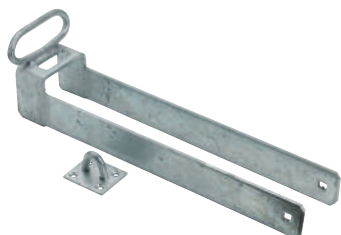

No.157S

Security Throw Over Loop for 3" Gates

Secures joining points of gates together.

- For 3" gates

Code	Size	Finish	Box Qty	Ctn Qty
157S0450GV	450mm 18"	Galv'd	-	5

With securing staple

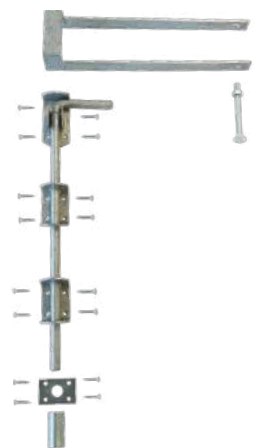

No.259/PP

Prepacked Double Gate Fastener Sets

Secures joining points of gates together. For 3" gates.

- 1 x 18" No.260 Garage Door Drop Bolt
- 1 x No.588 Tubular Receiver & Square Plate Receiver
- 1 x 14" No.156M Medium Throw Over Loop
- Supplied with fittings

Code	Size	Finish	Box Qty	Ctn Qty
259-PP0350GV	350mm 14"	Galv'd	1	5

LOOKING FOR MORE DROP BOLTS?

From Garage Door Drop Bolts to Heavy Surface Bolts, see the full range on page 39



No.500

Self-Locking Auto Gate Catch

The classic gate catch, used in conjunction with a striker. Gate locks automatically when closed.

Code	Size	Finish	Box Qty	Ctn Qty
500-0000GV	-	Galv'd	-	10



No.500



No.502/PP

Self-Locking Auto Gate Catch & Striker Pin

Excellent for gates and doors.

- Complete locking auto kit
- Supplied with fittings

Code	Size	Finish	Box Qty	Ctn Qty
502-PP0000GV	-	Galv'd	1	10

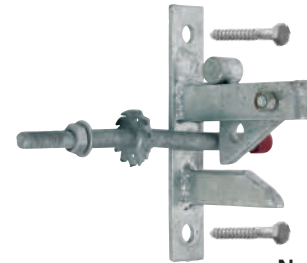

No.502/PP

No.503

Hunting Type Self-Locking Auto Gate Catch

Large crank makes unlocking and opening gates easier.

- Designed to enable horse riders to open gates without dismounting

Code	Size	Finish	Box Qty	Ctn Qty
503-0000GV	-	Galv'd	-	10

No.503



No.503L



No.503L/PP



No.503L

Hunting Type Lift Catch Self-Locking Auto Gate Catch

Lifting ring makes unlocking and opening gates easier.

Code	Size	Finish	Box Qty	Ctn Qty
503L0000GV	-	Galv'd	-	10

No.503L/PP

Hunting Type Lift Catch Self-Locking Auto Gate Catch PrePacked

- Supplied with striker pin and fixings

Code	Size	Finish	Box Qty	Ctn Qty
503LPP0000GV	-	Galv'd	-	10



No.506

Animal Safety Self-Locking Auto Gate Catch Kit

Safety rings prevent animals from being able to open the gate or hurt themselves.

Code	Size	Finish	Box Qty	Ctn Qty
506-0000GV	-	Galv'd	-	10



No.506/PP

Animal Safety Self-Locking Auto Gate Catch Kit - PrePacked

- Supplied with striker and fixings

Code	Size	Finish	Box Qty	Ctn Qty
506-PP0000GV	-	Galv'd	-	10

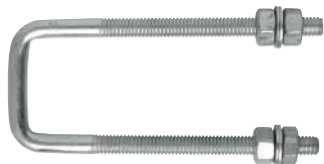

No.504

Double Leg Striker - Adjustable

Fitted to the end of a field gate or entrance gate to close into a closing latch.

Code	Size	Finish	Box Qty	Ctn Qty
504-0000ZP	-	BZP-E/Galv	-	10



No.508

Heavy Gate Catch to Drive (12mm dia.)

Use with a No.500 and 503.

Code	Size	Finish	Box Qty	Ctn Qty
508-0000GV	-	Galv'd	10	50



No.1311

Gate Staple on Elongated Plate

Extended plate increases strength, life and durability.

- Galvanised for maximum protection

Code	Size	Finish	Box Qty	Ctn Qty
13110075GV	75mm 3"	Galv'd	-	10



No.501

Cranked Striker Pin for 75mm 3" Gates

For use in conjunction with No.500 Self Locking Auto Gate Catch.

Code	Size	Finish	Box Qty	Ctn Qty
501-0075ZP	-	BZP-E/Galv	10	60
501-0075GV	-	Galv'd	10	60



No.187

Straight Striker Pin

For 75mm 3" gates.

Code	Size	Finish	Box Qty	Ctn Qty
187-0180GV	-	Galv'd	10	60

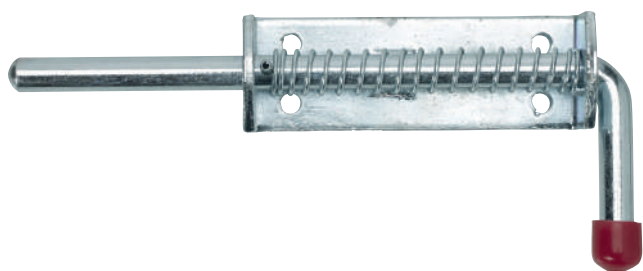

No.513

Spring Loaded Bolts

Ideal for securing gates and doors.

- Widely used within the agricultural/equestrian industry

Code	Size	Finish	Box Qty	Ctn Qty
513-0010ZP	10mm	BZP-E/Galv	10	80
513-0012ZP	12mm	BZP-E/Galv	-	10
513-0016ZP	16mm	BZP-E/Galv	-	5

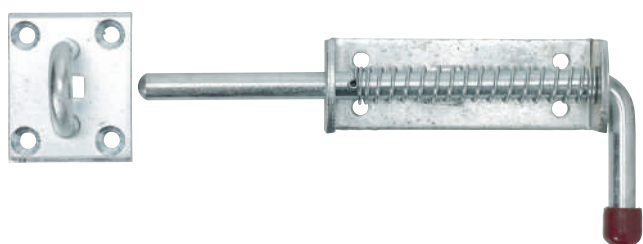

No.514

Spring Loaded Animal Bolts c/w HS9 Staple

Ideal for securing gates and doors.

- Widely used within the agricultural/equestrian industry

Code	Size	Finish	Box Qty	Ctn Qty
514-0000ZP	12mm	BZP-E/Galv	-	10

No.516

Safety Gate Hook & Eye

Designed to prevent the opening of gates by animals.

Code	Size	Finish	Box Qty	Ctn Qty
516-0150GV	150mm 6"	Galv'd	10	50

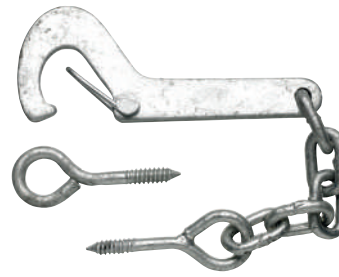

No.496

Devon Pattern Gate Drops

Animal proof when used with a padlock.

Code	Size	Finish	Box Qty	Ctn Qty
496-0150GV	150mm 6"	Galv'd	-	20



No.496/PP

Devon Pattern Gate Drops with Gate Staples

Includes 1x 100mm No.408 Gate Staple & 1x 63mm No.408 Gate Staple

Code	Size	Finish	Box Qty	Ctn Qty	Barcode
496-PP0150GV	150mm 6"	Galv'd	-	5	5023353272721

No.7A

Auto Locking Pig Bolts

A very strong security product.

• Generally used on pigsty

Code	Size	Finish	Box Qty	Ctn Qty
7A-0000GV	150mm 6"	Galv'd	-	10

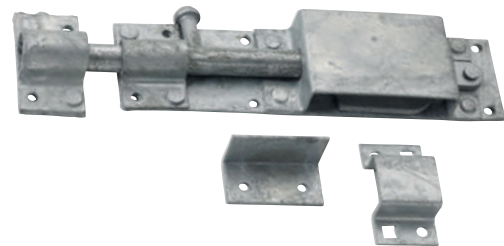

No.409

NZ Pattern Gate Chain Fastener Sets

Gives additional security and stops gate from swinging open.

• Complete with fixing staple

Code	Size	Finish	Box Qty	Ctn Qty
409-0420ZP	420mm 16 1/2"	BZP-E/Galv	-	10
409-1000ZP	1000mm 39"	BZP-E/Galv	-	10



No.940

Heavy Duty Spring Loaded Gate Wheels

Load Capacity: 135kg. Spring Compression: 55kg. Wheel Diameter: 100mm 4". Clearance to bottom of spring: 190mm approx.

• 2" 50mm maximum compression of spring

Code	Size	Finish	Box Qty	Ctn Qty
940-0000BK	368mm	Black	-	5



No.940

No.941

Medium Duty Spring Loaded Gate Wheels

Load Capacity: 57kg. Medium duty spring loaded gate wheel with a swivel 100mm solid plastic wheel with a plain bore.

• 1.5" 40mm maximum compression of spring

Code	Size	Finish	Box Qty	Ctn Qty
941-0000ZP	284mm	BZP-E/Galv	-	5



No.941

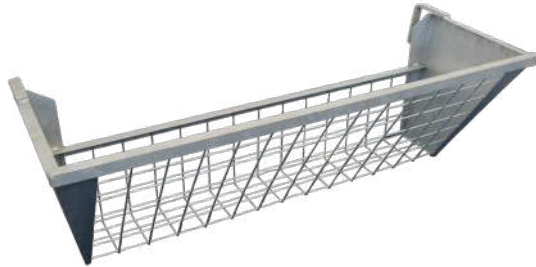

4ft Hook Over Sheep Hayrack

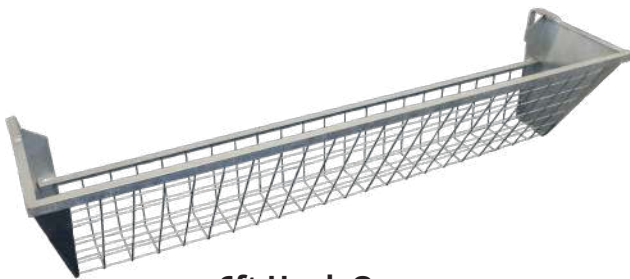

6ft Hook Over Sheep Hayrack



No.204

Hook Over Sheep Hayracks

Suitable for use on Sheep Hurdles or Metal Fieldgates, they provide versatility in placement. Featuring sheeted end panels to minimize hay wastage and maintain a clean feeding environment.

- Sheeted end panels
- 75mm x 75mm Mesh
- 400mm wide x 420mm deep (240mm back)
- Hook brackets welded on

Code	Size	Finish
204-1200GV	4ft	Galv'd
204-1800GV	6ft	Galv'd

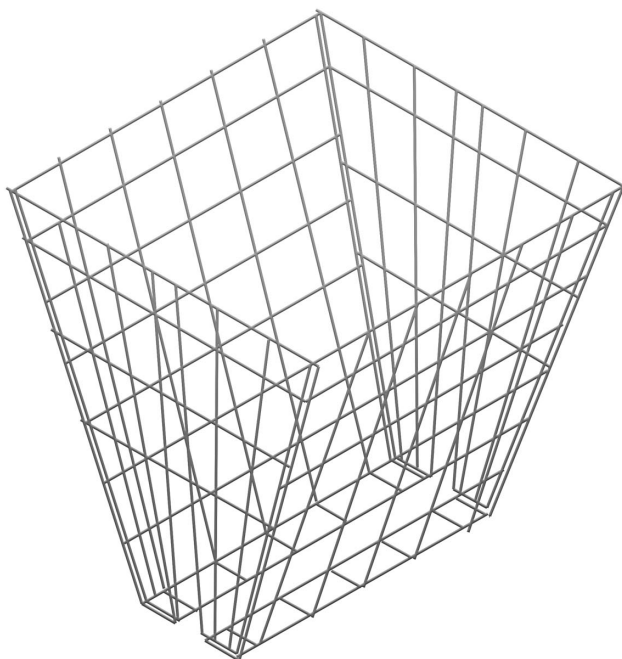

No.203

Double Sided Mesh Hay Baskets

- 75mm x 75mm Mesh
- Ideal for lambing and calving pens
- Universal design compatible with most major brands

Code	Size	Qty	Finish
203-0475GV	475mm x 475mm x 490mm	10	Galv'd

AGRICULTURAL

GATE & SHED

FENCING & LANDSCAPING

DOMESTIC & INTERNAL

ARCHITECTURAL IRONMONGERY

WIRE FORMED PRODUCTS

PACKAGING OPTIONS

BESPOKE LASER CUTTING



No.2159

Beef Feed Trough

Introducing our Beef Feed Trough, a reliable and spacious solution for feeding cattle. The ergonomic height of 675mm promotes easy access and natural feeding behaviour.

- 2400 x 786mm x 230mm deep trough
- Stands 675mm tall

Code	Size	Finish
2159-2400GV	8ft	Galv'd



No.2160

Badger Defence Kit

The spinning rollers are fitted on all four side, acting as a deterrent to Badgers drinking from the trough. This helps stop the spread of TB.

- Defence kit to prevent Badgers drinking from the trough
- To suit 8ft Beef Trough (No.2159)

Code	Size	Finish
2160-0000GV	-	Galv'd



No.2161

Sheep Feed Trough

Introducing our Sheep Feed Trough, a practical and reliable solution with a compact design and durable construction for efficient sheep feeding.

- 284mm x 163mm deep trough

Code	Size	Finish
2161-2700GV	9ft	Galv'd

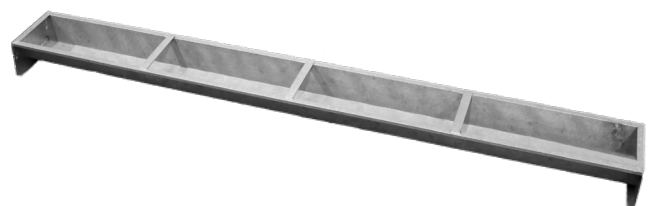

AGRICULTURAL

GATE & SHED

FENCING & LANDSCAPING

DOMESTIC & INTERNAL

ARCHITECTURAL IRONMONGERY

WIRE FORMED PRODUCTS

PACKAGING OPTIONS

BESPOKE LASER CUTTING



No.1310

Straight Trailer Hitch Eyes

Code	Size	Finish	Box Qty	Ctn Qty
13100300SC	300mm 12"	Self Colour	-	-
13100400SC	400mm 16"	Self Colour	-	-



No.169

Straight Hinges with No Holes

A multi-purpose product mainly used for welding onto trailers, HGV Trucks and various industrial applications.

- 12.5mm eye

Code	Size	Finish	Box Qty	Ctn Qty
169-0150SC	150mm 6"	Self Colour	5	25



No.1319

Pattern Drop Forged Hinge to Weld on Plate

- 12.7mm eye

Code	Size	Finish	Box Qty	Ctn Qty
13190000SC	-	Self Colour	5	50



No.1307

Trailer Hinge Pins to Weld

A forging welded onto a lorry or trailer bed to accommodate drop-side hinge.

- Trailer hinge slides onto the pin
- Self-coloured cast steel

Code	Size	Finish	Box Qty	Ctn Qty
13070012SC	12mm ½"	Self Colour	10	100
13070016SC	16mm 5/8"	Self Colour	10	100



No.1306

Trailer Hinge Pins to Bolt

For Rolled Tailgate Hinges, trailer hinge slides onto the pin.

- Bolts onto bottom of the trailer
- Self-coloured cast steel

Code	Size	Finish	Box Qty	Ctn Qty
13060012SC	12mm ½"	Self Colour	10	100



No.1308

Short Tailboard Rope Hooks (100mm Overall)

Designed to be bolted on. Ideal for heavy duty steel tippers, trailers and drop-side truck.

Code	Size	Finish	Box Qty	Ctn Qty
13080100ZP	8mm 5/16"	BZP-E/Galv	10	100
13080100SC12	12mm ½"	Self Colour	10	100

No.1309

Antiluce Fasteners to Weld

Code	Size	Finish	Box Qty	Ctn Qty
13090012ZP	12mm ½"	BZP-E/Galv	20	200



No.3263

Short Pattern Antiluce Fasteners to Bolt

Complete with one M12 Nylock Nut and one Round Washer.

Code	Size	Finish	Box Qty	Ctn Qty
32630025ZP	25mm 1"	BZP-E/Galv	20	200



No.1317

Bolt On Baby Antiluce Fasteners - M8 Thread

With M8 thread, washers and hex nut.

Code	Size	Finish	Box Qty	Ctn Qty
13170000ZP	20mm	BZP-E/Galv	20	600



No.3244

Long Pattern Antiluce Fasteners to Bolt

Complete with one M12 Nylock Nut and one Round Washer.

Code	Size	Finish	Box Qty	Ctn Qty
32440075ZP	75mm 3"	BZP-E/Galv	20	-



No.1324

Long Pattern Bolt On Baby Antiluce Fasteners - M8 Thread

With M8 thread, washers and hex nut.

Code	Size	Finish	Box Qty	Ctn Qty
13240000ZP	38mm	BZP-E/Galv	20	400



No.1300

Lynch Pins & 45mm Rings

• Also available in an Assortment Pack No.1300-AST01-YP see page 215

Code	Size	Finish	Box Qty	Ctn Qty
13000060YP	6mm	BZP-Y/P	25	1000
13000080YP	8mm	BZP-Y/P	25	1000
13000110YP	11mm	BZP-Y/P	25	1000



No.1301

Spring Cotters

• Also available in an Assortment Pack No.1301-AST01-ZP see page 215

Code	Size	Finish	Box Qty	Ctn Qty
13010070ZP	70mm x 3mm	BZP-E/Galv	50	2550
13010075ZP	75mm x 4mm	BZP-E/Galv	50	1000
13010100ZP	100mm x 5mm	BZP-E/Galv	50	500
13010125ZP	125mm x 6mm	BZP-E/Galv	50	400



AGRICULTURAL

GATE & SHED

FENCING & LANDSCAPING

DOMESTIC & INTERNAL

ARCHITECTURAL IRONMONGERY

WIRE FORMED PRODUCTS

PACKAGING OPTIONS

BESPOKE LASER CUTTING

Approx Thickness - 15mm



Fully Recyclable

No.7093

Rubber Stable & Stall Matting - Standard

- Eco-friendly, non-toxic, made from fully recyclable rubber
- Bubble top and grooved bottom

Code	Size	Thickness	Weight	Finish	MOQ
7093-0000BK	6ft x 4ft	15mm	30Kg	Black	50

Approx Thickness - 19mm



Fully Recyclable

No.7093H

Rubber Stable & Stall Matting - Heavy Duty

- Heavy duty, high quality thick rubber
- Eco-friendly, non-toxic, made from fully recyclable rubber
- Bubble top and grooved bottom
- Thicker and more durable than standard matting

Code	Size	Thickness	Weight	Finish	MOQ
7093H0000BK	6ft x 4ft	19mm	40Kg	Black	40

Thickness - 22mm



Fully Recyclable

No.7094

Rubber Grass Matting

- Eco-friendly, non-toxic, made from fully recyclable rubber
- Hollow openings for drainage

Code	Size	Thickness	Weight	Finish	MOQ
7094-0000BK	1.5m x 1.0m	22mm	13Kg	Black	60

Thickness - 20mm



Fully Recyclable

No.7198

4 Side Interlocking Rubber Parlour Matting

- Eco-friendly, non-toxic, made from fully recyclable rubber
- Interlocking sides to allow for easy connection

Code	Size	Thickness	Weight	Finish	Ctn Qty
7198-0000BK	6ft x 4ft	20mm	41Kg	Black	40

AGRICULTURAL

GATE & SHED

FENCING & LANDSCAPING

DOMESTIC & INTERNAL

ARCHITECTURAL IRONMONGERY

WIRE FORMED PRODUCTS

PACKAGING OPTIONS

BESPOKE LASER CUTTING

QUICKGRAB

Rubber Matting Grabber

No.7167

QuickGrab Rubber Matting Grabber

- Grab and pull rubber matting with ease
- Non-slip, safe single hand operation
- Heavy duty ABS body
- Pull over 200kg!

Code	Size	Finish	Box Qty	Ctn Qty
7167-0000BL	250mm x 142mm	Blue	5	20



No.833

Slip Rail Brackets

A simple holder for slip rails, providing easy access to paddocks.

- Complete with 4 x BZP Wood Screws

Code	Size	Finish	Box Qty	Ctn Qty
833-0000GV	-	Galv'd	1	5

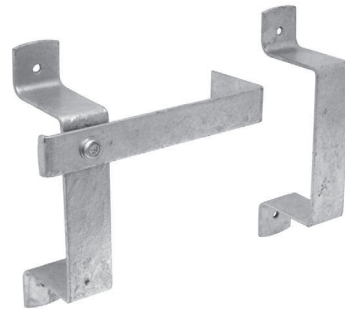

No.188

Slip Rail Holder

A simple holder for slip rails, providing easy access to paddocks.

Code	Size	Finish	Pack Qty	Packs per Box
188-100050GV	100mm x 50mm	Galv'd	1	25
188-100075GV	100mm x 75mm	Galv'd	1	25



No.189

Open Top Slip Rail Holder

A simple holder for slip rails, providing easy access to paddocks.

Code	Size	Finish	Pack Qty	Packs per Box
189-0000GV	-	Galv'd	1	25



No.190

Half Round Slip Rail Holder

A simple holder for slip rails, providing easy access to paddocks.

Code	Size	Finish	Pack Qty	Packs per Box
190-0000GV	-	Galv'd	1	25



AGRICULTURAL

GATE & SHED

FENCING & LANDSCAPING

DOMESTIC & INTERNAL

ARCHITECTURAL IRONMONGERY

WIRE FORMED PRODUCTS

PACKAGING OPTIONS

BESPOKE LASER CUTTING



No.127

Heavy Reversible Hinges

Heavy duty reversible hinges.

- Often used to hang gates, garage doors and particularly popular on stable doors.
- Cups are fitted to the hinge top and bottom which prevents the gates/doors from being lifted off.

Code	Size	Finish	Box Qty	Ctn Qty
127-0450BK	450mm 18"	Black	-	4
127-0500BK	500mm 20"	Black	-	4
127-0600BK	600mm 24"	Black	-	2
127-0750BK	750mm 30"	Black	-	2
127-0900BK	900mm 36"	Black	-	2
127-0300GV	300mm 12"	Galv'd	-	5
127-0350GV	350mm 14"	Galv'd	-	5
127-0400GV	400mm 16"	Galv'd	-	5
127-0450GV	450mm 18"	Galv'd	-	4
127-0500GV	500mm 20"	Galv'd	-	4
127-0600GV	600mm 24"	Galv'd	-	2
127-0750GV	750mm 30"	Galv'd	-	2
127-0900GV	900mm 36"	Galv'd	-	2

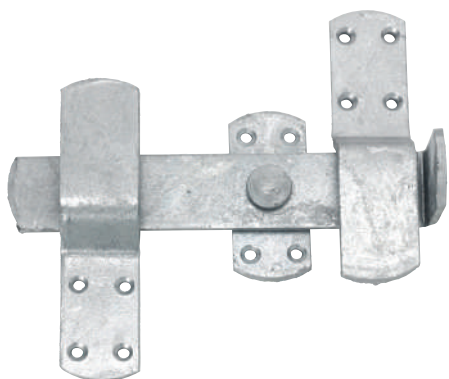

No.509

Kickover Stable Latches

Designed to enable hands free opening of stable doors by use of foot.

- Available in multiple colours
- Galvanised for maximum protection

Code	Size	Finish	Box Qty	Ctn Qty
509-0000GV	-	Galv'd	-	5

No.519

Manger Ring on Welded Eye Bolt

Fitted with 2 hex nuts and 2 round washers. Used to restrain animals by bolting through timber or brickwork in stables, stalls or animal pens.

- Zinc plated for a smoother finish



Code	Size	Finish	Box Qty	Ctn Qty
519-0150ZP	150mm 6"	BZP-E/Galv	10	80
519-0300ZP	300mm 12"	BZP-E/Galv	10	60



GATE & SHED

Bands & Hooks	28	Gate Accessories	38
Tee Hinges	30	Door & Gate Bolts	39
Gate Catches & Latches	33	Tower & Padlock Bolts	41
Gate Packs	36	Hasps & Staples	43
Cabin Hooks	37	Gate & Shed Locks	46



No.140

Hooks on Plates

For use on field gates.

- Enable gate to be lifted on or off for maintenance purposes.

Code	Size	Finish	Box Qty	Ctn Qty
140-0012BK	12mm	Black	-	10
140-0016BK	16mm	Black	-	10
140-0019BK	19mm	Black	-	10
140-0012GV	12mm	Galv'd	-	10
140-0016GV	16mm	Galv'd	-	10
140-0019GV	19mm	Galv'd	-	10

**Alternative
 Patterns Available
 Upon Request**

No.128

Straight Bands with Hooks on Plates

A heavy duty band hinge used to hang gates and large doors.

- Use straight hinges to allow the gate/door to be proud of the post/frame

Code	Size	Finish	Box Qty	Ctn Qty
128-0250BK	250mm 10"	Black	-	5
128-0300BK	300mm 12"	Black	-	5
128-0400BK	400mm 16"	Black	-	5
128-0450BK	450mm 18"	Black	-	4
128-0500BK	500mm 20"	Black	-	4
128-0600BK	600mm 24"	Black	-	2
128-0750BK	750mm 30"	Black	-	2
128-0900BK	900mm 36"	Black	-	2
128-0250GV	250mm 10"	Galv'd	-	5
128-0300GV	300mm 12"	Galv'd	-	5
128-0350GV	350mm 14"	Galv'd	-	5
128-0400GV	400mm 16"	Galv'd	-	5
128-0450GV	450mm 18"	Galv'd	-	4
128-0500GV	500mm 20"	Galv'd	-	4
128-0600GV	600mm 24"	Galv'd	-	2
128-0750GV	750mm 30"	Galv'd	-	2
128-0900GV	900mm 36"	Galv'd	-	2
128-0250SC	250mm 10"	Self Colour	-	5
128-0300SC	300mm 12"	Self Colour	-	5
128-0350SC	350mm 14"	Self Colour	-	5
128-0450SS	450mm 18"	S/S	1	4
128-0600SS	600mm 24"	S/S	1	2



UKANDIN IN HOUSE MANUFACTURING CAPABILITY

Pressed Steel & Aluminium • Forged Steel & Brass
 Casting • Thread Rolling • Wire Forming
 Injection Moulding • Finishing • Laser Cutting



AGRICULTURAL
 GATE & SHED
 FENCING & LANDSCAPING
 DOMESTIC & INTERNAL
 ARCHITECTURAL IRONMONGERY
 WIRE FORMED PRODUCTS
 PACKAGING OPTIONS
 BESPOKE LASER CUTTING

No.130

Cranked Bands with Hooks on Plates

Cranked hinges keep the post flush with the door/gate.

• Use cranked hinges when the gate/door and post/frame are flush

Code	Size	Finish	Box Qty	Ctn Qty
130-0250BK	250mm 10"	Black	-	5
130-0300BK	300mm 12"	Black	-	5
130-0350BK	350mm 14"	Black	-	5
130-0400BK	400mm 16"	Black	-	5
130-0450BK	450mm 18"	Black	-	4
130-0500BK	500mm 20"	Black	-	4
130-0600BK	600mm 24"	Black	-	2
130-0750BK	750mm 30"	Black	-	2
130-0900BK	900mm 36"	Black	-	2
130-1050BK	1050mm 42"	Black	-	1
130-1200BK	1200mm 48"	Black	-	1
130-0200GV	200mm 8"	Galv'd	-	10
130-0250GV	250mm 10"	Galv'd	-	5
130-0300GV	300mm 12"	Galv'd	-	5
130-0350GV	350mm 14"	Galv'd	-	5
130-0400GV	400mm 16"	Galv'd	-	5
130-0450GV	450mm 18"	Galv'd	-	4
130-0500GV	500mm 20"	Galv'd	-	4
130-0600GV	600mm 24"	Galv'd	-	2
130-0750GV	750mm 30"	Galv'd	-	2
130-0900GV	900mm 36"	Galv'd	-	2
130-1050GV	1050mm 42"	Galv'd	-	1
130-1200GV	1200mm 48"	Galv'd	-	1
130-0400SC	400mm 16"	Self Colour	-	5
130-0750SC	750mm 30"	Self Colour	-	2
130-0450SS	450mm 18"	S/S	1	4
130-0600SS	600mm 24"	S/S	1	2



No.113

Adjustable Bands & Hooks on Plates

Adjustable band and hook for accurate placement of gates.

- A slightly lighter construction than our No.112, with a slightly shorter eye bolt
- Galvanised for maximum protection
- Black powder coating for stylish looks
- Ideal for driveway and entrance gates
- Allows adjustment whilst fitting or at a later stage
- Commonly used in conjunction with automated closing gate systems

Code	Size	Finish	Box Qty	Ctn Qty
113-PPSET0BK	350mm 14"	Black	-	5
113-PPSET1BK	450mm 18"	Black	-	5
113-PPSET2BK	600mm 24"	Black	-	2
113-PPSET3BK	750mm 30"	Black	-	2
113-PPSET4BK	900mm 36"	Black	-	2
113-PPSET0GV	350mm 14"	Galv'd	-	5
113-PPSET1GV	450mm 18"	Galv'd	-	5
113-PPSET2GV	600mm 24"	Galv'd	-	2
113-PPSET3GV	750mm 30"	Galv'd	-	2
113-PPSET4GV	900mm 36"	Galv'd	-	2

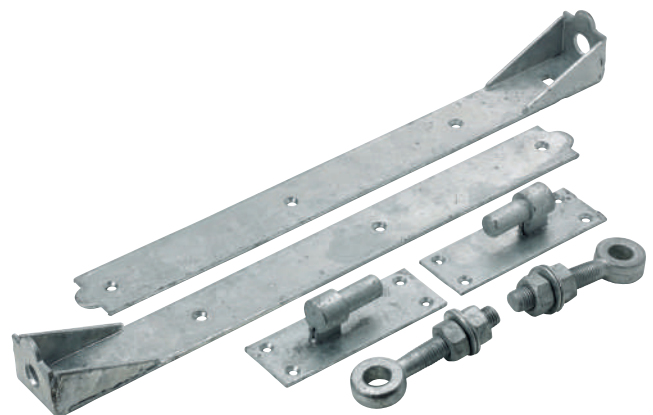

Contents:

- 1 pair of Adjustable Bands
- 1 pair of Hook on Plates
- 1 pair of 100mm Precision Eyebolts
- Supplied with fittings



No.121A

Light Tee Hinges

For use on light gates and shed manufacturing.

Code	Size	Finish	Box Qty	Ctn Qty
121A0100BK	100mm 4"	Black	10	140
121A0150BK	150mm 6"	Black	10	100
121A0200BK	200mm 8"	Black	10	60
121A0250BK	250mm 10"	Black	10	40
121A0300BK	300mm 12"	Black	10	40
121A0100ZP	100mm 4"	BZP-E/Galv	10	140
121A0150ZP	150mm 6"	BZP-E/Galv	10	100
121A0200ZP	200mm 8"	BZP-E/Galv	10	60
121A0250ZP	250mm 10"	BZP-E/Galv	10	40
121A0300ZP	300mm 12"	BZP-E/Galv	10	40



No.121

Medium Tee Hinges

Normally fitted to standard weight gates and sheds.

Code	Size	Finish	Box Qty	Ctn Qty
121-0250BK	250mm 10"	Black	-	10
121-0300BK	300mm 12"	Black	-	10
121-0350BK	350mm 14"	Black	-	10
121-0375BK	375mm 15"	Black	-	10
121-0400BK	400mm 16"	Black	-	10
121-0450BK	450mm 18"	Black	-	10
121-0600BK	600mm 24"	Black	-	5
121-0250ZP	250mm 10"	BZP-E/Galv	-	10
121-0300ZP	300mm 12"	BZP-E/Galv	-	10
121-0350ZP	350mm 14"	BZP-E/Galv	-	10
121-0375ZP	375mm 15"	BZP-E/Galv	-	10
121-0400ZP	400mm 16"	BZP-E/Galv	-	10
121-0450ZP	450mm 18"	BZP-E/Galv	-	10
121-0600ZP	600mm 24"	BZP-E/Galv	-	5
121-0300GV	300mm 12"	Galv'd	-	10
121-0350GV	350mm 14"	Galv'd	-	10
121-0375GV	375mm 15"	Galv'd	-	10
121-0400GV	400mm 16"	Galv'd	-	10
121-0450GV	450mm 18"	Galv'd	-	10
121-0600GV	600mm 24"	Galv'd	-	5



No.120

Strong Tee Hinges

Fitted generally on heavier gates.

Code	Size	Finish	Box Qty	Ctn Qty
120-0150BK	150mm 6"	Black	10	60
120-0200BK	200mm 8"	Black	10	40
120-0250BK	250mm 10"	Black	-	10
120-0300BK	300mm 12"	Black	-	10
120-0350BK	350mm 14"	Black	-	10
120-0400BK	400mm 16"	Black	-	10
120-0450BK	450mm 18"	Black	-	10
120-0500BK	500mm 20"	Black	-	10
120-0600BK	600mm 24"	Black	-	5
120-0150ZP	150mm 6"	BZP-E/Galv	10	60
120-0200ZP	200mm 8"	BZP-E/Galv	10	40
120-0250ZP	250mm 10"	BZP-E/Galv	-	10
120-0300ZP	300mm 12"	BZP-E/Galv	-	10
120-0350ZP	350mm 14"	BZP-E/Galv	-	10
120-0400ZP	400mm 16"	BZP-E/Galv	-	10
120-0450ZP	450mm 18"	BZP-E/Galv	-	10
120-0500ZP	500mm 20"	BZP-E/Galv	-	10
120-0600ZP	600mm 24"	BZP-E/Galv	-	5
120-0300GV	300mm 12"	Galv'd	-	10
120-0350GV	350mm 14"	Galv'd	-	10
120-0400GV	400mm 16"	Galv'd	-	10
120-0450GV	450mm 18"	Galv'd	-	10
120-0500GV	500mm 20"	Galv'd	-	10
120-0600GV	600mm 24"	Galv'd	-	5

Alternative
Patterns Available
Upon Request



No.910

Heavy Tee Hinges

Excellent for high use gates, sheds, stores and garden furniture.

• Manufactured from heavier gauge steel for strength and reliability

Code	Size	Finish	Box Qty	Ctn Qty
910-0100ZP	100mm 4"	BZP-E/Galv	5	65
910-0150ZP	150mm 6"	BZP-E/Galv	5	35
910-0230ZP	230mm 9"	BZP-E/Galv	5	30
910-0300ZP	300mm 12"	BZP-E/Galv	5	20
910-0350ZP	350mm 14"	BZP-E/Galv	5	10
910-0375ZP	375mm 15"	BZP-E/Galv	5	10
910-0400ZP	400mm 16"	BZP-E/Galv	5	-
910-0450ZP	450mm 18"	BZP-E/Galv	5	-
910-0600ZP	600mm 24"	BZP-E/Galv	2	-



No.119

Weighty Scotch Tee Hinges

A very strong hinge for heavy gates.

Code	Size	Finish	Box Qty	Ctn Qty
119-0100ZP	100mm 4"	BZP-E/Galv	5	50
119-0150ZP	150mm 6"	BZP-E/Galv	5	30
119-0200ZP	200mm 8"	BZP-E/Galv	5	20
119-0250ZP	250mm 10"	BZP-E/Galv	5	15
119-0300ZP	300mm 12"	BZP-E/Galv	5	15
119-0350ZP	350mm 14"	BZP-E/Galv	-	5
119-0400ZP	400mm 16"	BZP-E/Galv	-	5
119-0450ZP	450mm 18"	BZP-E/Galv	-	5
119-0600ZP	600mm 24"	BZP-E/Galv	-	2
119-0100GV	100mm 4"	Galv'd	5	50
119-0150GV	150mm 6"	Galv'd	5	30
119-0200GV	200mm 8"	Galv'd	5	20
119-0250GV	250mm 10"	Galv'd	5	15
119-0300GV	300mm 12"	Galv'd	5	15
119-0350GV	350mm 14"	Galv'd	-	5
119-0400GV	400mm 16"	Galv'd	-	5
119-0450GV	450mm 18"	Galv'd	-	5
119-0500GV	500mm 20"	Galv'd	-	5
119-0600GV	600mm 24"	Galv'd	-	2
119-0100SC	100mm 4"	Self Colour	5	50
119-0150SC	150mm 6"	Self Colour	5	30
119-0200SC	200mm 8"	Self Colour	5	20
119-0250SC	250mm 10"	Self Colour	5	15
119-0300SC	300mm 12"	Self Colour	5	15
119-0350SC	350mm 14"	Self Colour	-	5
119-0400SC	400mm 16"	Self Colour	-	5
119-0450SC	450mm 18"	Self Colour	-	5



No.124L

Light Straight Strap Hinges

Measurement is each leaf not overall.

Code	Size	Finish	Box Qty	Ctn Qty
124L0100ZP	100mm 4"	BZP-E/Galv	10	100
124L0150ZP	150mm 6"	BZP-E/Galv	10	40
124L0200ZP	200mm 8"	BZP-E/Galv	10	30
124L0150SC	150mm 6"	Self Colour	10	40
124L0200SC	200mm 8"	Self Colour	10	30



UKANDIN IN HOUSE MANUFACTURING CAPABILITY

Pressed Steel & Aluminium • Forged Steel & Brass
 Casting • Thread Rolling • Wire Forming
 Injection Moulding • Finishing • Laser Cutting





No.1136

Plain Ring Handled Gate Latches

A traditional style gate latch.

- Normally fitted to side gates/doors
- Heavy duty catch, keep and rose

Code	Size	Finish	Box Qty	Ctn Qty
11360125BK	125mm 5"	Black	5	20
11360150BK	150mm 6"	Black	5	20
11360180BK	180mm 7"	Black	5	20
11360125ZP	125mm 5"	BZP-E/Galv	5	20
11360150ZP	150mm 6"	BZP-E/Galv	5	20
11360180ZP	180mm 7"	BZP-E/Galv	5	20
11360125GV	125mm 5"	Galv'd	5	20
11360150GV	150mm 6"	Galv'd	5	20
11360180GV	180mm 7"	Galv'd	5	20

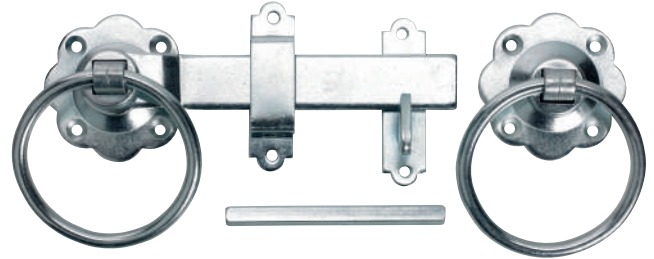

No.1137

Twisted Ring Handle Gate Latch Sets

A traditional style gate latch with twisted ring handle.

- Normally fitted to side gates/doors
- Heavy duty catch, keep and rose

Code	Size	Finish	Box Qty	Ctn Qty
11370150BK	150mm 6"	Black	5	20
11370180BK	180mm 7"	Black	5	20
11370150GV	150mm 6"	Galv'd	5	20
11370180GV	180mm 7"	Galv'd	5	20

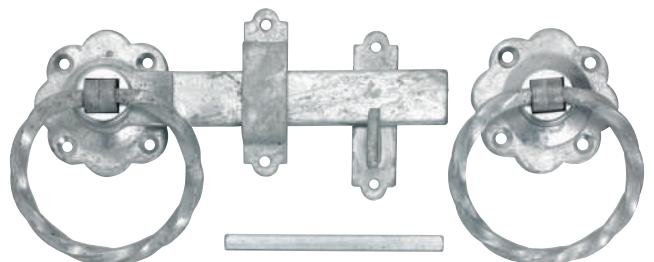

AGRICULTURAL

GATE & SHED

FENCING & LANDSCAPING

DOMESTIC & INTERNAL

ARCHITECTURAL IRONMONGERY

WIRE FORMED PRODUCTS

PACKAGING OPTIONS

BESPOKE LASER CUTTING

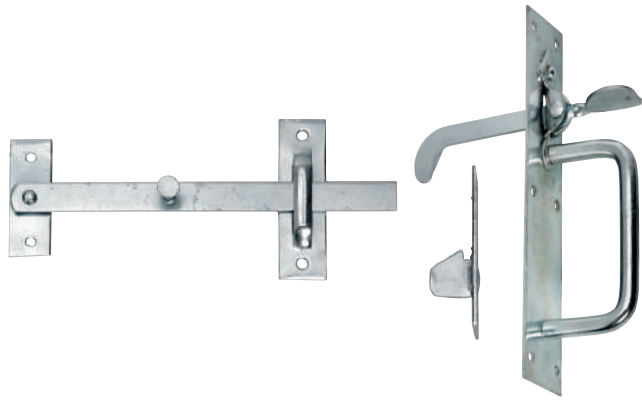

No.20/2S

Light Suffolk Latches - Std. Thumb Piece

The classic gate latch set.

- Simple, strong and efficient
- Size stated is depth of gate at point of latch placement

Code	Size	Finish	Box Qty	Ctn Qty
20/20000BK	75mm	Black	5	40
20/20000ZP	75mm	BZP-E/Galv	5	40

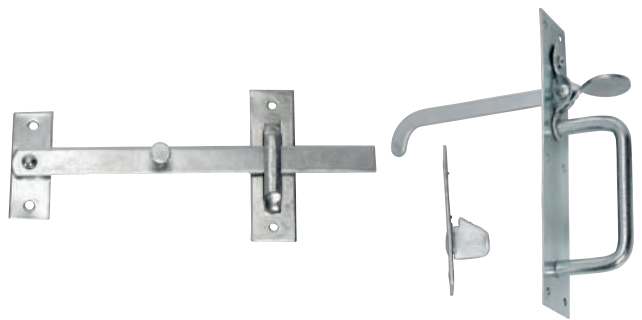

No.20/2L

Light Suffolk Latches - Long Thumb Piece

The classic gate latch set.

- Simple, strong and efficient
- Size stated is depth of gate at point of latch placement

Code	Size	Finish	Box Qty	Ctn Qty
20/2L000BK	108mm	Black	5	40
20/2L000ZP	108mm	BZP-E/Galv	5	40



No.20/4S

Medium Suffolk Latches - Std. Thumb Piece

The classic gate latch set.

- Simple, strong and efficient
- Size stated is depth of gate at point of latch placement

Code	Size	Finish	Box Qty	Ctn Qty
20/4S000BK	75mm	Black	5	20
20/4S000ZP	75mm	BZP-E/Galv	5	20
20/4S000GV	75mm	Galv'd	5	20



No.20/4L

Medium Suffolk Latches - Long Thumb Piece

The classic gate latch set.

- Simple, strong and efficient
- Size stated is depth of gate at point of latch placement

Code	Size	Finish	Box Qty	Ctn Qty
20/4L000BK	108mm	Black	5	20
20/4L000ZP	108mm	BZP-E/Galv	5	20
20/4L000GV	108mm	Galv'd	5	20

No.50/4S

Heavy Suffolk Latches - Std. Thumb Piece

The classic gate latch set.

- Simple, strong and efficient
- Size stated is depth of gate at point of latch placement

Code	Size	Finish	Box Qty	Ctn Qty
50/4S000BK	75mm	Black	5	20
50/4S000ZP	75mm	BZP-E/Galv	5	20
50/4S000GV	75mm	Galv'd	5	20

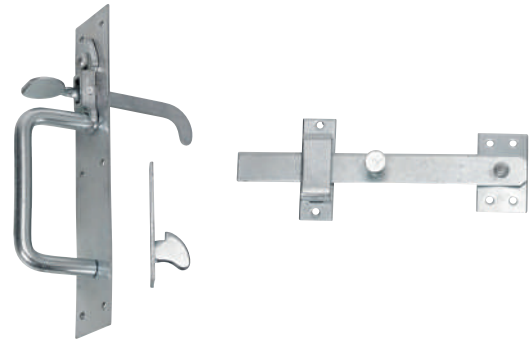

No.50/4L

Heavy Suffolk Latches - Long. Thumb Piece

The classic gate latch set.

- Simple, strong and efficient
- Size stated is depth of gate at point of latch placement

Code	Size	Finish	Box Qty	Ctn Qty
50/4L000BK	108mm	Black	-	10
50/4L000ZP	108mm	BZP-E/Galv	-	10
50/4L000GV	108mm	Galv'd	-	10

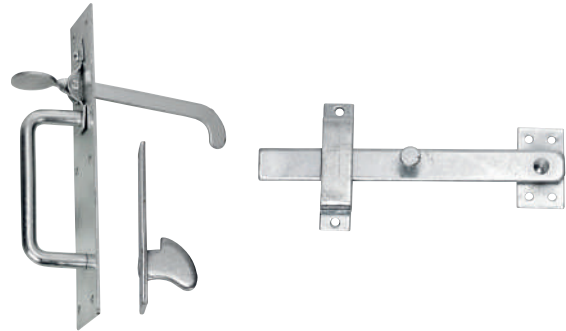

No.5040

Drop Latch, Keep & Catch

The classic gate latch.

- Simple, strong and efficient

Code	Size	Finish	Box Qty	Ctn Qty
5040000BK	-	Black	10	50



No.5040C

Heavy Catch Only

To suit No.5040.

- Simple and efficient

Code	Size	Finish	Box Qty	Ctn Qty
5040C000BK	-	Black	10	100



No.1932

Medium Auto Gate Catches

A medium duty multi-purpose gate catch.

Code	Size	Finish	Box Qty	Ctn Qty
19320000BK	-	Black	10	100
19320000ZP	-	BZP-E/Galv	10	100
19320000GV	-	Galv'd	10	100



No.1822

Heavy Auto Gate Catches

A heavy duty multi-purpose gate catch.

Code	Size	Finish	Box Qty	Ctn Qty
18220000BK	57mm	Black	10	40
18220000GV	57mm	Galv'd	10	40

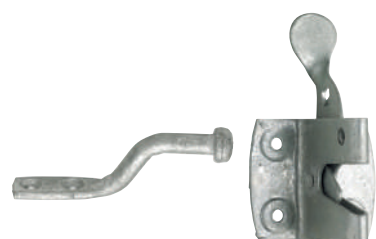

AGRICULTURAL

GATE & SHED

FENCING & LANDSCAPING

DOMESTIC & INTERNAL

ARCHITECTURAL IRONMONGERS

WIRE FORMED PRODUCTS

PACKAGING OPTIONS

BESPOKE LASER CUTTING

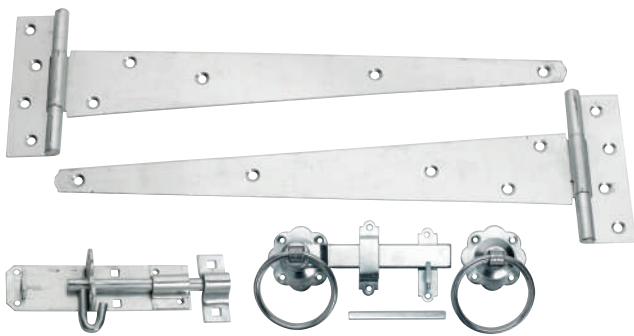
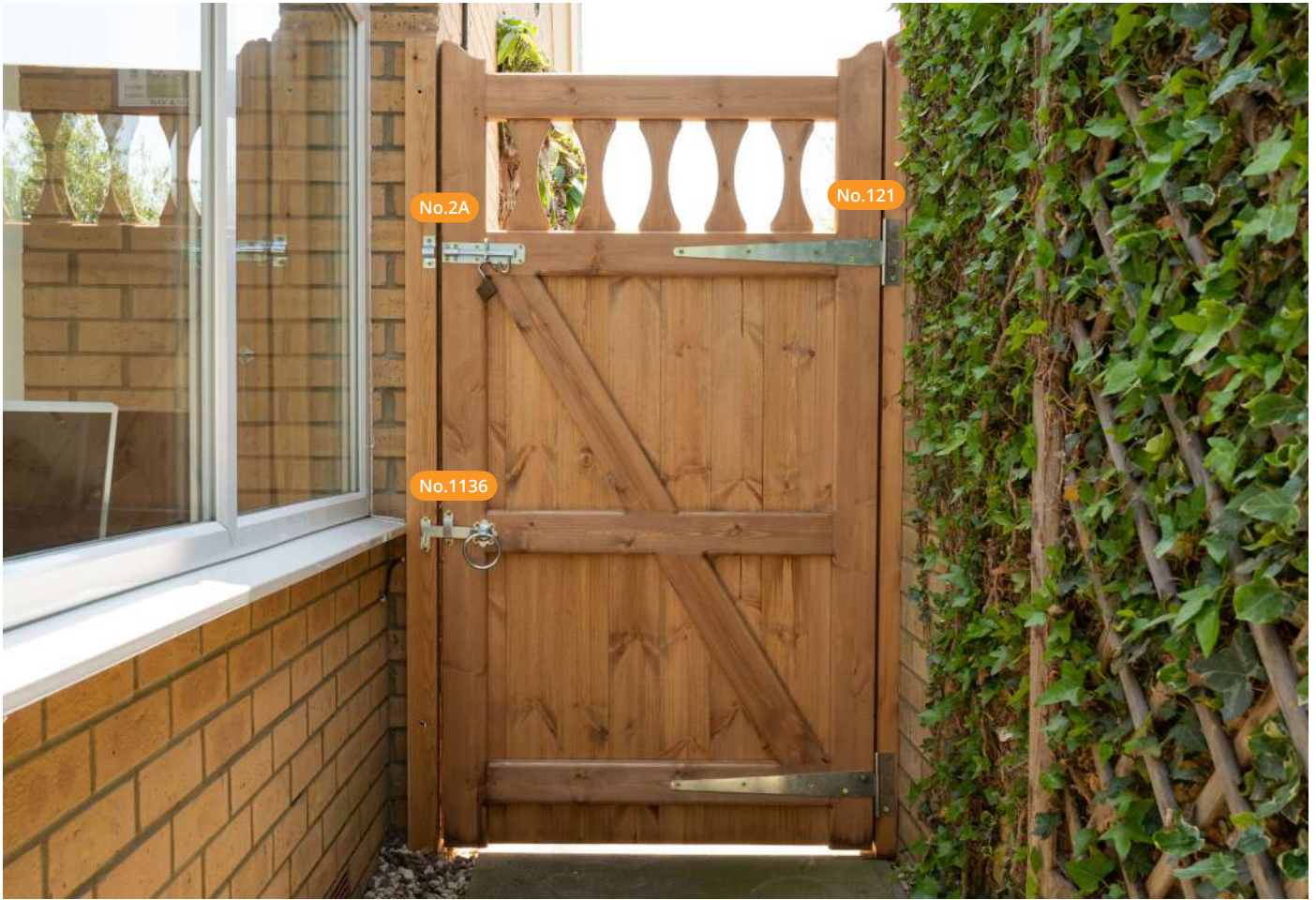

No.GPB

Gate Hardware Pack B with Fittings

Ideal for use on side gates.

Code	Size	Finish	Box Qty	Ctn Qty
GPB121-0300GV	300mm 12"	Galv'd	5	-
GPB121-0450BK	450mm 18"	Black	5	-
GPB121-0450ZP	450mm 18"	BZP-E/Galv	5	-
GPB121-0450GV	450mm 18"	Galv'd	5	-

Contents: 1 pair of Tee Hinges, 1 each 150mm No.1136 Plain Ring Handle Gate Latch, 1 each 150mm No.2A Brenton Padlock Bolt, Supplied with fittings

GATE PACKS

CUSTOM SHED OR GATE FIXING PACKS

We offer custom gate and shed hardware packs to suit your requirements.

Speak to your Sales Account Manager or contact Sales.

Minimum order quantities required.

No.2814

Wire Cabin Hooks

Used for securing or restraining doors or gates.

• A very economical product

Code	Size	Finish	Box Qty	Ctn Qty
28140075BK	75mm 3"	Black	10	150
28140100BK	100mm 4"	Black	10	150
28140150BK	150mm 6"	Black	10	80
28140200BK	200mm 8"	Black	10	80
28140250BK	250mm 10"	Black	10	80
28140300BK	300mm 12"	Black	10	60
28140450BK	450mm 18"	Black	10	30
28140600BK	600mm 24"	Black	10	20
28140075ZP	75mm 3"	BZP-E/Galv	10	150
28140100ZP	100mm 4"	BZP-E/Galv	10	150
28140150ZP	150mm 6"	BZP-E/Galv	10	80
28140200ZP	200mm 8"	BZP-E/Galv	10	80
28140250ZP	250mm 10"	BZP-E/Galv	10	60
28140300ZP	300mm 12"	BZP-E/Galv	10	60
28140075GV	75mm 3"	Galv'd	10	150
28140100GV	100mm 4"	Galv'd	10	150
28140150GV	150mm 6"	Galv'd	10	80
28140200GV	200mm 8"	Galv'd	10	80
28140250GV	250mm 10"	Galv'd	10	60
28140300GV	300mm 12"	Galv'd	10	60
28140450GV	450mm 18"	Galv'd	10	30
28140600GV	600mm 24"	Galv'd	10	20



No.37

Traditional Cast Cabin Hooks

Used for securing or restraining doors or gates.

• A traditionally cast product

Code	Size	Finish	Box Qty	Ctn Qty
37-0100BK	100mm 4"	Black	10	100
37-0150BK	150mm 6"	Black	10	80
37-0200BK	200mm 8"	Black	10	60
37-0250BK	250mm 10"	Black	10	40
37-0300BK	300mm 12"	Black	10	40
37-0100GV	100mm 4"	Galv'd	10	100
37-0150GV	150mm 6"	Galv'd	10	80
37-0200GV	200mm 8"	Galv'd	10	60
37-0250GV	250mm 10"	Galv'd	10	40
37-0300GV	300mm 12"	Galv'd	10	40



AGRICULTURAL

GATE & SHED

FENCING & LANDSCAPING

DOMESTIC & INTERNAL

ARCHITECTURAL IRONMONGERY

WIRE FORMED PRODUCTS

PACKAGING OPTIONS

BESPOKE LASER CUTTING



No.1928

Tubular Steel Handles

Extremely versatile and hard wearing handle.

- For use on doors, gates and cabinets

Code	Size	Finish	Box Qty	Ctn Qty
19280150BK	150mm 6"	Black	25	200
19280180BK	180mm 7"	Black	25	200
19280150ZP	150mm 6"	BZP-E/Galv	25	200
19280180ZP	180mm 7"	BZP-E/Galv	25	200



No.891

Hot Bed Handles

Extremely versatile and hard wearing handle.

- For use on doors, gates and cabinets

Code	Size	Finish	Box Qty	Ctn Qty
891-0150BK	150mm 6"	Black	25	125
891-0180BK	180mm 7"	Black	25	125
891-0150GV	150mm 6"	Galv'd	25	125
891-0180GV	180mm 7"	Galv'd	25	125



No.517/C

Contractors Gate Spring

A more economical and lighter alternative to the standard gate spring.

Code	Size	Finish	Box Qty	Ctn Qty
517C000BK	200mm	Black	5	50

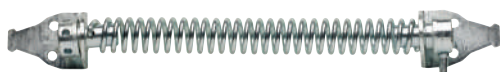

No.517

Gate Spring

A general purpose return spring for assisting in the closure of gates.

Code	Size	Finish	Box Qty	Ctn Qty
517-0200BK	200mm 8"	Black	-	10
517-0250BK	250mm 10"	Black	-	10
517-0200ZP	200mm 8"	BZP-E/Galv	-	10
517-0250ZP	250mm 10"	BZP-E/Galv	-	10

No.260

Garage Door Drop Bolts

A general purpose garage door drop bolt.

- Multiple applications
- Bolt diameter is 16mm

Code	Size	Finish	Box Qty	Ctn Qty
260-PP0300BK	300mm 12"	Black	1	5
260-PP0375BK	375mm 15"	Black	1	5
260-PP0450BK	450mm 18"	Black	1	5
260-PP0600BK	600mm 24"	Black	1	5
260-PP0900BK	900mm 36"	Black	1	5
260-PP0300GV	300mm 12"	Galv'd	1	5
260-PP0375GV	375mm 15"	Galv'd	1	5
260-PP0450GV	450mm 18"	Galv'd	1	5
260-PP0600GV	600mm 24"	Galv'd	1	5



No.260TR

Traditional Garage Door Drop Bolts

A general purpose garage door drop bolt with welded guides.

- Fixings Included
- Multiple applications
- Bolt diameter is 16mm

Code	Size	Finish	Box Qty	Ctn Qty
260TR300BK	300mm 12"	Black	5	-
260TR450BK	450mm 18"	Black	5	-
260TR600BK	600mm 24"	Black	5	-
260TR300GV	300mm 12"	Galv'd	5	-
260TR450GV	450mm 18"	Galv'd	5	-
260TR600GV	600mm 24"	Galv'd	5	-

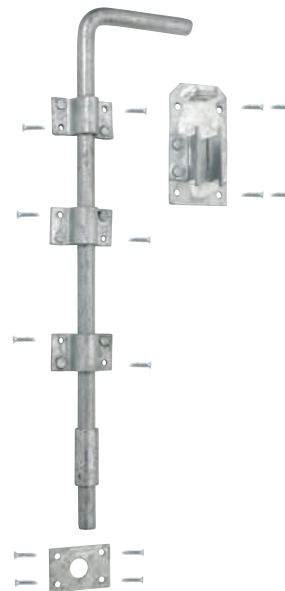

No.260H

Heavy Duty Garage Door Drop Bolts

Very strong, heavy duty product.

- Multiple applications
- Bolt diameter is 16mm

Code	Size	Finish	Box Qty	Ctn Qty
260H0300GV	300mm 12"	Galv'd	-	5
260H0450GV	450mm 18"	Galv'd	-	5
260H0600GV	900mm 36"	Galv'd	-	5



AGRICULTURAL

GATE & SHED

FENCING & LANDSCAPING

DOMESTIC & INTERNAL

ARCHITECTURAL IRONMONGERY

WIRE FORMED PRODUCTS

PACKAGING OPTIONS

BESPOKE LASER CUTTING



No.262

Heavy Lockable Surface Bolt

Very strong, robustly constructed product.

- For spare or replacement staples use No.HS9

Code	Size	Finish	Box Qty	Ctn Qty
262-0375GV	375mm 15"	Galv'd	-	5
262-0450GV	450mm 18"	Galv'd	-	5
262-0600GV	600mm 24"	Galv'd	-	5



No.213/PP

Cane Bolts

A very strong security product.

- Generally used on large garage, industrial and agricultural type doors

Code	Size	Finish	Box Qty	Ctn Qty
213-PP0300BK	300mm 12"	Black	1	10



No.597

Heavy Cross Pattern Door Bolts

A very strong security product.

- Generally used on large garage, industrial and agricultural type doors

Code	Size	Finish	Box Qty	Ctn Qty
597-0300GV	300mm 12"	Galv'd	-	5
597-0450GV	450mm 18"	Galv'd	-	5
597-0600GV	600mm 24"	Galv'd	-	5

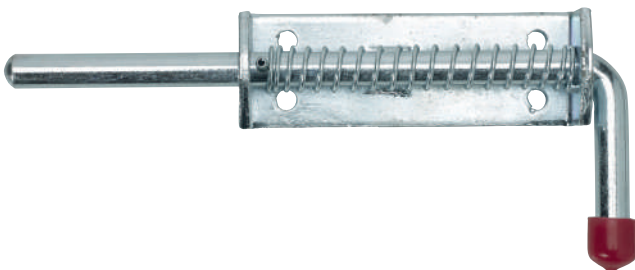

No.513

Spring Loaded Bolts

Ideal for securing gates and doors.

- Widely used within the agricultural/equestrian industry and

Code	Size	Finish	Box Qty	Ctn Qty
513-0010ZP	10mm	BZP-E/Galv	10	80
513-0012ZP	12mm	BZP-E/Galv	-	10
513-0016ZP	16mm	BZP-E/Galv	-	5

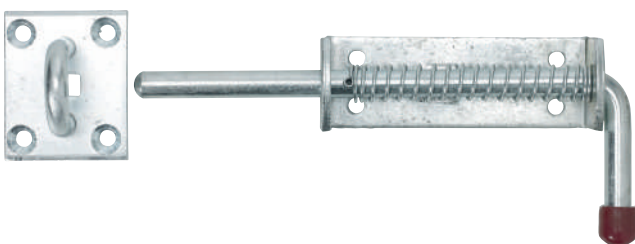

No.514

Spring Loaded Animal Bolts c/w HS9Staple

Ideal for securing gates and doors.

- Widely used within the agricultural/equestrian industry

Code	Size	Finish	Box Qty	Ctn Qty
514-0000ZP	12mm	BZP-E/Galv	-	10

No.923A

Enclosed Tower Bolts

A standard straight sliding bolt ideal for sheds, outbuildings and as additional security on domestic doors. Supplied with a staple-style bolt keep.

Code	Size	Finish	Box Qty	Ctn Qty
923A0075BK	75mm 3"	Black	10	100
923A0100BK	100mm 4"	Black	10	100
923A0150BK	150mm 6"	Black	10	60
923A0200BK	200mm 8"	Black	10	40
923A0250BK	250mm 10"	Black	10	30
923A0300BK	300mm 12"	Black	10	20
923A0075ZP	75mm 3"	BZP-E/Galv	10	100
923A0100ZP	100mm 4"	BZP-E/Galv	10	100
923A0150ZP	150mm 6"	BZP-E/Galv	10	60
923A0200ZP	200mm 8"	BZP-E/Galv	10	40
923A0250ZP	250mm 10"	BZP-E/Galv	10	30
923A0300ZP	300mm 12"	BZP-E/Galv	10	20
923A0075GV	75mm 3"	Galv'd	10	100
923A0100GV	100mm 4"	Galv'd	10	100
923A0150GV	150mm 6"	Galv'd	10	60
923A0200GV	200mm 8"	Galv'd	10	40
923A0250GV	250mm 10"	Galv'd	10	30
923A0300GV	300mm 12"	Galv'd	10	20



No.923N

Necked Enclosed Tower Bolts

Cranked sliding bolt often used on double doors or doors with recessed frames.

- Can fit vertically or horizontally and use a flat retaining plate instead of a staple
- Fitted with Enclosed Steel Shoots

Code	Size	Finish	Box Qty	Ctn Qty
923N0100BK	100mm 4"	Black	10	100
923N0150BK	150mm 6"	Black	10	60
923N0200BK	200mm 8"	Black	10	40
923N0100ZP	100mm 4"	BZP-E/Galv	10	100
923N0150ZP	150mm 6"	BZP-E/Galv	10	60
923N0200ZP	200mm 8"	BZP-E/Galv	10	40
923N0150GV	150mm 6"	Galv'd	10	60



No.4A

Oval Padlock Bolt

A simple and efficient lockable gate securing bolt.

Code	Size	Finish	Box Qty	Ctn Qty
4A-0000BK	-	Black	10	60
4A-0000ZP	-	BZP-E/Galv	10	60
4A-0000GV	-	Galv'd	10	60

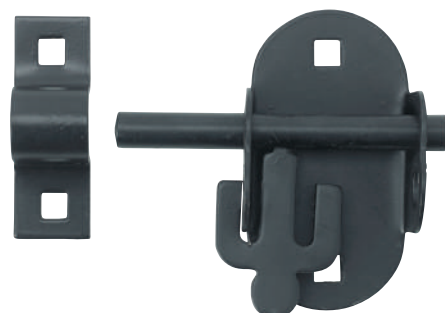

AGRICULTURAL

GATE & SHED

FENCING & LANDSCAPING

DOMESTIC & INTERNAL

ARCHITECTURAL IRONMONGERY

WIRE FORMED PRODUCTS

PACKAGING OPTIONS

BESPOKE LASER CUTTING

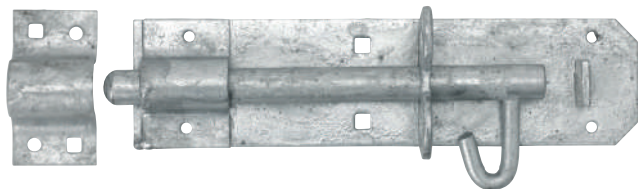

No.1A

Heavy Brenton Padlock Bolts

Straight, tough, hardened steel plated barrel bolt.

- Heavy duty construction
- 16mm diameter shoot

Code	Size	Finish	Box Qty	Ctn Qty
1A--0150BK	150mm 6"	Black	5	25
1A--0150ZP	150mm 6"	BZP-E/Galv	5	25
1A--0200ZP	200mm 8"	BZP-E/Galv	5	20
1A--0250ZP	250mm 10"	BZP-E/Galv	5	15
1A--0300ZP	300mm 12"	BZP-E/Galv	5	10
1A--0150GV	150mm 6"	Galv'd	5	25
1A--0200GV	200mm 8"	Galv'd	5	20
1A--0250GV	250mm 10"	Galv'd	5	15
1A--0300GV	300mm 12"	Galv'd	5	10



No.1AHKEEP

Elongated Keep for No.1A Brenton Bolts

This elongated staple allows vertical movement of the door or gate, while still accepting the bolt.

Code	Size	Finish	Box Qty	Ctn Qty
1A/HKEEPGV	-	Galv'd	25	200

No.2A

Medium Brenton Padbolts.

A multi-purpose lockable door or gate bolt.

- Medium duty construction
- 12mm diameter shoot

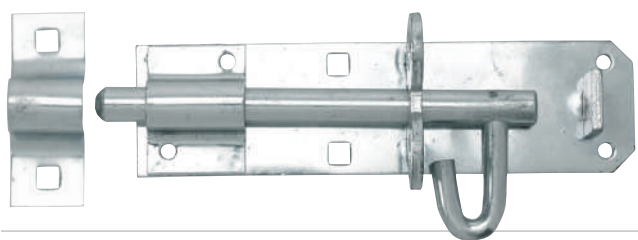

Code	Size	Finish	Box Qty	Ctn Qty
2A--0100BK	100mm 4"	Black	5	40
2A--0150BK	150mm 6"	Black	5	30
2A--0200BK	200mm 8"	Black	5	30
2A--0250BK	250mm 10"	Black	5	20
2A--0300BK	300mm 12"	Black	5	20
2A--0100ZP	100mm 4"	BZP-E/Galv	5	40
2A--0150ZP	150mm 6"	BZP-E/Galv	5	30
2A--0200ZP	200mm 8"	BZP-E/Galv	5	30
2A--0250ZP	250mm 10"	BZP-E/Galv	5	20
2A--0300ZP	300mm 12"	BZP-E/Galv	5	20
2A--0100GV	100mm 4"	Galv'd	5	40
2A--0150GV	150mm 6"	Galv'd	5	30
2A--0200GV	200mm 8"	Galv'd	5	30
2A--0250GV	250mm 10"	Galv'd	5	20
2A--0300GV	300mm 12"	Galv'd	5	20

No.HS617

Safety Hasps & Staples

General purpose hasp and staple.

- Generally fitted to sheds, greenhouses and many other applications

Code	Size	Finish	Box Qty	Ctn Qty
HS617-0075BK	75mm 3"	Black	10	100
HS617-0115BK	115mm 4½"	Black	10	100
HS617-0150BK	150mm 6"	Black	10	60
HS617-0075ZP	75mm 3"	BZP-E/Galv	10	100
HS617-0115ZP	115mm 4½"	BZP-E/Galv	10	100
HS617-0150ZP	150mm 6"	BZP-E/Galv	10	60



No.HS618

Heavy Safety Hasps & Staple

Heavier duty general purpose hasp and staple.

- Used with a lock on garage doors and other medium weight situations
- Also available in PerryPack

Code	Size	Finish	Box Qty	Ctn Qty
HS618-0000BK	180mm	Black	5	20
HS618-0000GV	180mm	Galv'd	5	20



No.HS145

Short Heavy Hasps & Staple

Heavier duty general purpose hasp and staple.

- Used with a lock on garage doors and other medium weight door situations

Code	Size	Finish	Box Qty	Ctn Qty
HS145-0000BK	150mm	Black	5	25
HS145-0000GV	150mm	Galv'd	5	25

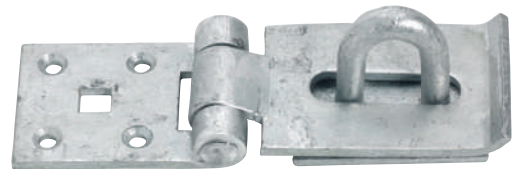

No.HS146

Heavy Vertical Hasps & Staples

A very strong lockable product.

- Multiple applications
- Ideal for securing doors and gates on buildings

Code	Size	Finish	Box Qty	Ctn Qty
HS146-0000BK	150mm 6"	Black	5	20
HS146-0000ZP	150mm 6"	BZP-E/Galv	5	20
HS146-0000GV	150mm 6"	Galv'd	5	20

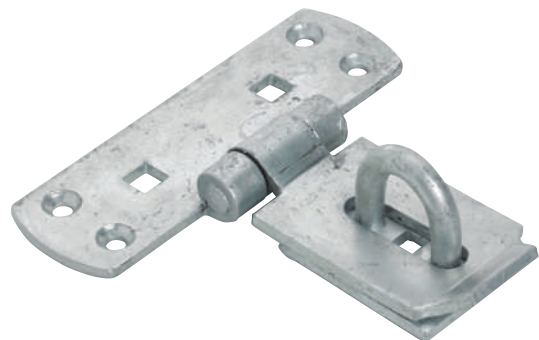

AGRICULTURAL

GATE & SHED

FENCING & LANDSCAPING

DOMESTIC & INTERNAL

ARCHITECTURAL IRONMONGERY

WIRE FORMED PRODUCTS

PACKAGING OPTIONS

BESPOKE LASER CUTTING

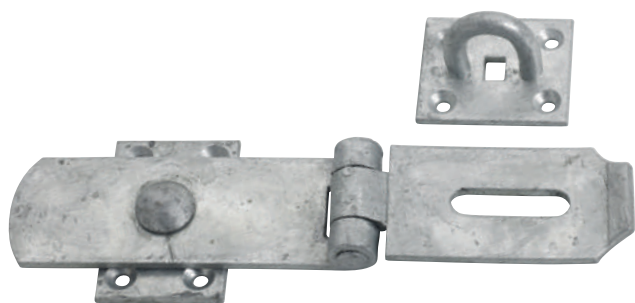

No.HS147

Heavy Swivel Locking Bars

A very strong lockable product.

- Multiple functions but primarily designed for securing and locking double doors

Code	Size	Finish	Box Qty	Ctn Qty
HS147-0200BK	200mm 8"	Black	5	15
HS147-0250BK	250mm 10"	Black	5	15
HS147-0300BK	300mm 12"	Black	5	15
HS147-0200GV	200mm 8"	Galv'd	5	15
HS147-0250GV	250mm 10"	Galv'd	5	15
HS147-0300GV	300mm 12"	Galv'd	5	15
HS147-0350GV	250mm 14"	Galv'd	5	10
HS147-0400GV	400mm 16"	Galv'd	5	10

No.HS149H

Heavy Hasps & Staples

A very strong lockable product.

- Designed to secure heavy weight doors



Code	Size	Finish	Box Qty	Ctn Qty
HS149H0200BK	200mm 8"	Black	5	20
HS149H0250BK	250mm 10"	Black	5	20
HS149H0300BK	300mm 12"	Black	5	15
HS149H0200ZP	200mm 8"	BZP-E/Galv	5	20
HS149H0250ZP	250mm 10"	BZP-E/Galv	5	20
HS149H0200GV	200mm 8"	Galv'd	5	20
HS149H0250GV	250mm 10"	Galv'd	5	20
HS149H0300GV	300mm 12"	Galv'd	5	15

No.HS149M

Medium Hasps & Staples

A lockable product widely used in multiple applications.

- Designed to secure medium weight doors



Code	Size	Finish	Box Qty	Ctn Qty
HS149M0200BK	200mm 8"	Black	10	40
HS149M0200ZP	200mm 8"	BZP-E/Galv	10	40
HS149M0200GV	200mm 8"	Galv'd	10	40

No.HS610

Wire Hasps & Staples

Multi-purpose product.

- Strong but light manufacture
- Designed for light applications

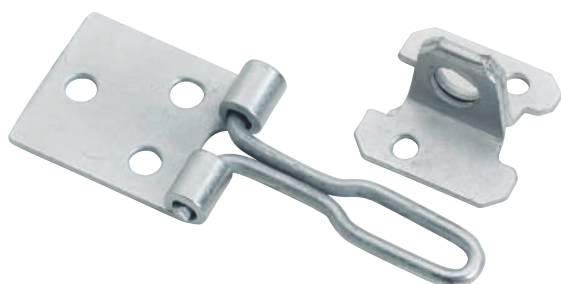

Code	Size	Finish	Box Qty	Ctn Qty
HS610-0075BK	75mm 3"	Black	50	400
HS610-0100BK	100mm 4"	Black	50	300
HS610-0075ZP	75mm 3"	BZP-E/Galv	50	400
HS610-0100ZP	100mm 4"	BZP-E/Galv	50	300

No.HS8

Medium Staples

For use with hasps.

- Ideal for gate and shed doors
- Steel manufacture

Code	Size	Finish	Box Qty	Ctn Qty
HS8---0000BK	-	Black	10	100
HS8---0000ZP	-	BZP-E/Galv	10	100
HS8---0000GV	-	Galv'd	10	100



No.HS9

Heavy Staples

For use with hasps.

- Ideal for gate and shed doors
- Steel manufacture

Code	Size	Finish	Box Qty	Ctn Qty
HS9---0000BK	-	Black	10	80
HS9---0000GV	-	Galv'd	10	80



No.15

Turn Buttons

A simple and very effective low cost catch.

- Multiple uses

Code	Size	Finish	Box Qty	Ctn Qty
15--0050BK	50mm 2"	Black	100	500
15--0063BK	63mm 2½"	Black	100	300
15--0050ZP	50mm 2"	BZP-E/Galv	100	500
15--0063ZP	63mm 2½"	BZP-E/Galv	100	300



No.18

Half Plain Turn Buttons

A simple and very effective low cost catch.

- Multiple uses

Code	Size	Finish	Box Qty	Ctn Qty
18--0032ZP	32mm	BZP-E/Galv	100	1000



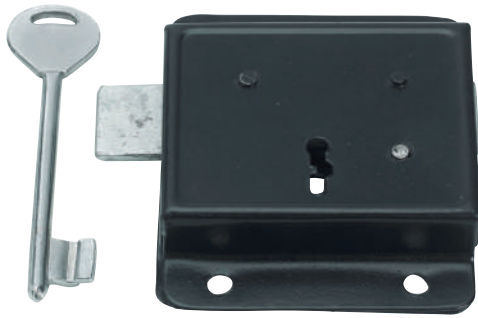

No.614

Presslock

Ideal for securing shed or greenhouse doors.

- Surface mounted fixing
- Key operated from one side
- Supplied with a key

Code	Size	Finish	Box Qty	Ctn Qty
614-0000BK	75mm 3" x 3"	Black	10	50

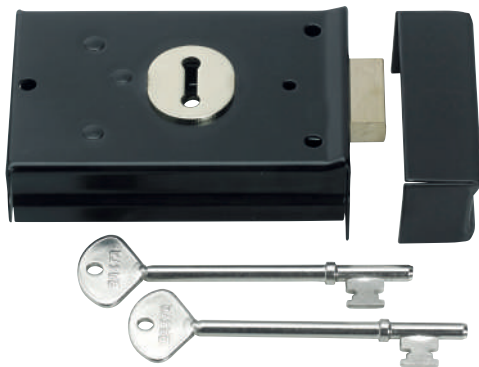

No.649

Double Handed Press Rim Locks

A high quality lock.

- Surface mounted fixing
- Complete with two keys and all fixing screws

Code	Size	Finish	Box Qty	Ctn Qty
649-0000BK	125mm 5" x 3 3/4"	Black	10	50



No.47G

Double Handed Rim Dead Locks

For use on external and internal doors, sheds and gates.

- Ideal for both left and right handed doors
- Key operates deadbolt from both sides
- Supplied with two keys, fittings and receiver plate

Code	Size	Finish	Box Qty	Ctn Qty
47G-0000BK	100mm 4" x 3"	Black	10	40

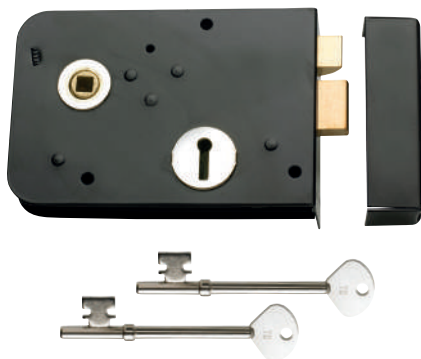

No.37G

Rim Locks

For use on external and internal doors, shed and gates.

- Ideal for both left and right handed doors

Code	Size	Finish	Box Qty	Ctn Qty
37GL0000BK	150mm 6" x 4"	Black	10	20
37GR0000BK	150mm 6" x 4"	Black	10	20

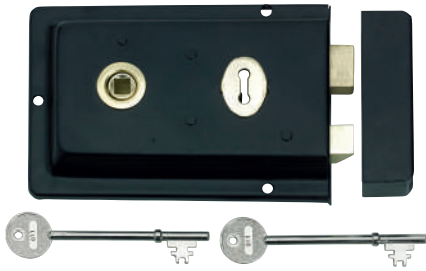

No.23G

Double Handed Rim Locks

Ideal for timber doors.

- Key operated deadbolt from both sides

Code	Size	Finish	Box Qty	Ctn Qty
23G-0000BK	150mm 6" x 4"	Black	10	20



No.38

Rim Deadlock with Snib

For use on external and internal timber doors, sheds and gates.

- Ideal for both left and right handed doors

Code	Size	Finish	Box Qty	Ctn Qty
38-0100BK	100mm x 75mm	Black	10	40



No.39

Narrow Rim Sashlock

For use on external and internal doors, sheds and gates.

- Key operates deadbolt

Code	Size	Finish	Box Qty	Ctn Qty
39-0140BK	140mm x 75mm	Black	10	20

LOOKING FOR DOOR KNOBS?

Discover the ideal door knob options that perfectly complement our rim locks.



PAGE 106

New
narrower
design for
fitting to 3"
timber

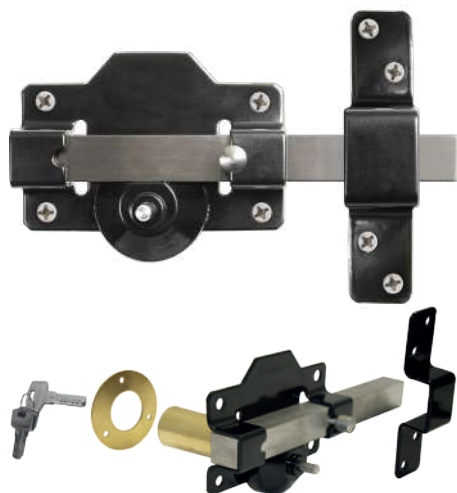

No.1126

Long Throw Lock - Single Locking

Premium high quality Single Locking Long Throw Lock manufactured by A. Perry can be opened by key from one side.

- Stainless Steel Bolt gives increased corrosion resistance even in coastal areas
- New narrower design for fitting to 3" timber

Code	Keyed	Size	Finish	Box Qty	Ctn Qty
11260050BK	Different	50mm	Black	1	20
11260070BK	Different	70mm	Black	1	20
1126A050BK	Alike	50mm	Black	1	20
1126A070BK	Alike	70mm	Black	1	20

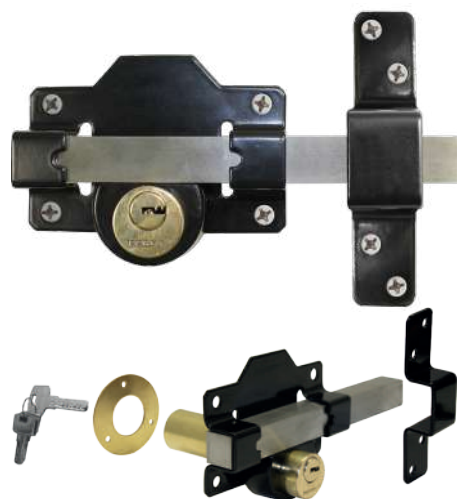

No.1127

Long Throw Lock - Double Locking

Premium high quality Single Locking Long Throw Lock manufactured by A. Perry can be opened by key from both side.

- Stainless Steel Bolt gives increased corrosion resistance even in coastal areas

Code	Keyed	Size	Finish	Box Qty	Ctn Qty
11270050BK	Different	50mm	Black	1	20
11270070BK	Different	70mm	Black	1	20
1127A050BK	Alike	50mm	Black	1	20
1127A070BK	Alike	70mm	Black	1	20



No.1125

Long Throw Lock Handles

Available in polished chrome, polished brass and black finishes.

- Made from solid brass

Code	Size	Finish	Box Qty	Ctn Qty
11250200BK	200mm	Black	1	25
11250200PB	200mm	Polished Brass	1	25
11250200PC	200mm	Polished Chrome	1	25



No.1126K

Spare Blank Keys to suit Long Throw Locks

Ideal for No.1126 & No.1127.

Code	Size	Finish	Box Qty	Ctn Qty
1126K000NP	-	Nickel Plated	10	1000

AGRICULTURAL

GATE & SHED

FENCING & LANDSCAPING

DOMESTIC & INTERNAL

ARCHITECTURAL IRONMONGERY

WIRE FORMED PRODUCTS

PACKAGING OPTIONS

BESPOKE LASER CUTTING



FENCING & LANDSCAPING

Sleeper Brackets	50	Fencing Accessories	58
Fence Post Support	52	Fencing System	64
Fencing Tools	56		

BRAND NEW

Sleeper brackets

Easily install railway sleepers, fast and securely



- ✓ Easy installation
- ✓ Super secure
- ✓ Fastened internally, no fixings showing
- ✓ Suitable with all sleeper sizes

AGRICULTURAL

GATE & SHED

FENCING & LANDSCAPING

DOMESTIC & INTERNAL

ARCHITECTURAL IRONMONGERY

WIRE FORMED PRODUCTS

PACKAGING OPTIONS

BESPOKE LASER CUTTING



No.4713

Single Sleeper Corner Support Spike

Used to secure the corner of a single layer of railway sleepers. Perfect for timber sleeper planters, pathway edging, and retaining walls.

- Extra shear angle for all types of ground with notches for extra grip
- Heavy-duty, 2mm thick material
- Suitable for all sleeper sizes

Code	Size	Finish	Box Qty	Ctn Qty
47130000BR	440mm	Brown	-	20
47130000PG	440mm	Pre-Galv'd	-	20

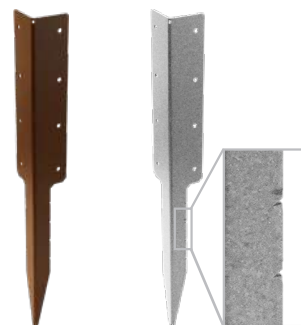

No.4714

Double Sleeper Corner Support Spike

Used to secure the corner of a double layer of railway sleepers.

- Extra shear angle for all types of ground with notches for extra grip
- Heavy-duty, 2mm thick material
- Suitable for all sleeper sizes

Code	Size	Finish	Box Qty	Ctn Qty
47140000BR	750mm	Brown	-	10
47140000PG	750mm	Pre-Galv'd	-	10



No.4715

Single Sleeper Straight Support Spike

Used to secure a straight run of railway sleepers and can be used to connect 2 sleepers together.

- Extra shear angle for all types of ground with notches for extra grip
- Heavy-duty, 2mm thick material
- Suitable for all sleeper sizes

Code	Size	Finish	Box Qty	Ctn Qty
47150000BR	440mm	Brown	-	20
47150000PG	440mm	Pre-Galv'd	-	20

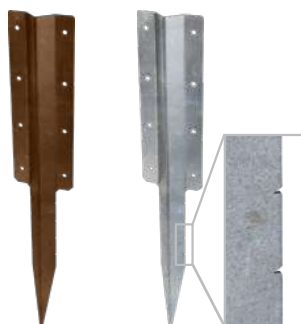

No.4716

Double Sleeper Straight Support Spike

Used to secure a straight run of railway sleepers that are more than 1 layer high. Can also be used to connect 2 sleepers together.

- Extra shear angle for all types of ground with notches for extra grip
- Heavy-duty, 2mm thick material
- Suitable for all sleeper sizes

Code	Size	Finish	Box Qty	Ctn Qty
47160000BR	660mm	Brown	-	10
47160000PG	660mm	Pre-Galv'd	-	10

No.4717

Internal Sleeper Corner Support Bracket

Used in conjunction with support spikes to secure the corner of railway sleepers on planters, pathway edging, and retaining walls.

- Heavy-duty, 2mm thick material
- Suitable for all sleeper sizes

Code	Size	Finish	Box Qty	Ctn Qty
47170000BR	85mm	Brown	-	20
47170000PG	85mm	Pre-GalV'd	-	20

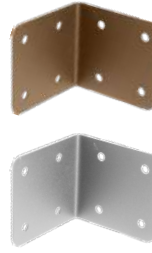

No.4718

Short Internal Sleeper Straight Flat Support Plate

Used in conjunction with support spikes to secure 2 straight railway sleepers together in the internal side of planters, pathway edging, and retaining walls.

- Heavy-duty, 2mm thick material
- Suitable for all sleeper sizes

Code	Size	Finish	Box Qty	Ctn Qty
47180000BR	170mm	Brown	-	20
47180000PG	170mm	Pre-GalV'd	-	20



No.4719

Long Internal Sleeper Straight Flat Support Plate

Large bracket used in conjunction with support spikes to secure up to 4 straight railway sleepers together in the internal side of planters, pathway edging, and retaining walls.

- Heavy-duty, 2mm thick material
- Suitable for all sleeper sizes

Code	Size	Finish	Box Qty	Ctn Qty
47190000BR	350mm	Brown	-	10
47190000PG	350mm	Pre-GalV'd	-	10



No.494

Sleeper / Base Anchor Bracket to Concrete In

Ideal for fixing timber sleepers in place and for the use of fixing post supports for pergolas, carports, garages, or other similar building projects.

- Designed to be used with wooden posts 3 x 3" (75mm) or 4 x 4" (100mm)
- Bracket size: 75mm (3") x 75mm (3"), bracket height: 100mm (4")
- 220mm long bar
- Four pre-drilled holes make for an efficient and easy fix

Code	Size	Finish	Box Qty	Ctn Qty
494-0075BR	75mm 3"	Brown	-	10
494-0075GV	75mm 3"	GalV'd	-	10

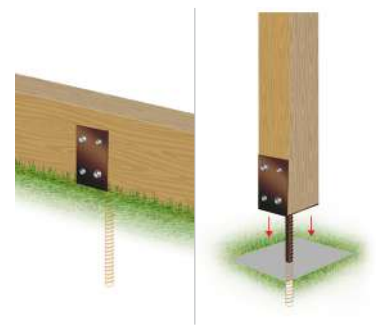
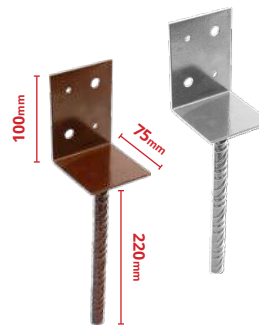

CERTIFIED QUALITY

YOUR EYES IN THE SUPPLY CHAIN

Fence Post Supports offer a vast range of options to suit all applications, they are the ideal solution for fitting fence posts, gazebos, pergolas, and other garden structures, without having to concrete the post directly into the ground.



Use No. 332 Driving Tool and appropriate ramming tool to drive into place. See page 54

No.4701

Bolt Grip Fence Post Support to Drive 600mm 24" Spike

Drive in post support allowing the installation of square timber posts quickly and securely directly into the ground without the need for concrete or additional fixings. The twin bolt fixing system is adjusted to hold the posts firmly.

Code	Size	Finish	Box Qty	Ctn Qty
47010075BR	75mm 3" x 3"	Brown	-	10
47010100BR	100mm 4" x 4"	Brown	-	10
47010075GV	75mm 3" x 3"	Galv'd	-	10
47010100GV	100mm 4" x 4"	Galv'd	-	10

No.4702

750mm 36" Spike

Code	Size	Finish	Box Qty	Ctn Qty
47020075BR	75mm 3" x 3"	Brown	-	10
47020100BR	100mm 4" x 4"	Brown	-	8
47020075GV	75mm 3" x 3"	Galv'd	-	10
47020100GV	100mm 4" x 4"	Galv'd	-	8



Use No. 332 Driving Tool and appropriate ramming tool to drive into place. See page 54

No.4700

Wedge Grip Fence Post Support to Drive 450mm 18" Spike

A fence post support that has a wedge grip system that secures the posts firmly, gripping the wood as it is driven into the square hole. The drive support has a four-fin steel spike that can be driven directly into the ground without the need for concrete or additional fixings.

Code	Size	Finish	Box Qty	Ctn Qty
47000050BR	50mm 2" x 2"	Brown	-	10
47000050GV	50mm 2" x 2"	Galv'd	-	10

No.4708

600mm 24" Spike

Code	Size	Finish	Box Qty	Ctn Qty
47080075BR	75mm 3" x 3"	Brown	-	10
47080075GV	75mm 3" x 3"	Galv'd	-	10

No.4709

750mm 36" Spike

Code	Size	Finish	Box Qty	Ctn Qty
47090075BR	75mm 3" x 3"	Brown	-	10
47090100BR	100mm 4" x 4"	Brown	-	10
47090075GV	75mm 3" x 3"	Galv'd	-	10
47090100GV	100mm 4" x 4"	Galv'd	-	10

AGRICULTURAL

GATE & SHED

FENCING & LANDSCAPING

DOMESTIC & INTERNAL

ARCHITECTURAL IRONMONGERY

WIRE FORMED PRODUCTS

PACKAGING OPTIONS

BESPOKE LASER CUTTING

They protect the post base from insects, fungal and water damage, and allow for the post to be removed or replaced with far less effort than if they were concreted in directly.

All our Fence Post supports are made from heavy gauge durable steel and available in powder coated brown or high-grade galvanising.

No.4705

Bolt Grip Fence Post Support to Bolt Down

A square timber post support that attaches to the ground with concrete bolts. To be used on surfaces such as concrete, paving, brick or wood and protects the post base from insects, fungal and water.

The twin bolt fixing system is adjusted to hold the post firmly.

Bolt down using M10 (50mm) or M12 (75mm+) Shield Anchors (6027/PP) or Concrete Bolts.

Code	Size	Finish	Box Qty	Ctn Qty
47050050BR	50mm 2" x 2"	Brown	-	10
47050075BR	75mm 3" x 3"	Brown	-	10
47050100BR	100mm 4" x 4"	Brown	-	10
47050150BR	150mm 6" x 6"	Brown	-	5
47050050GV	50mm 2" x 2"	Galv'd	-	10
47050075GV	75mm 3" x 3"	Galv'd	-	10
47050100GV	100mm 4" x 4"	Galv'd	-	10
47050150GV	150mm 6" x 6"	Galv'd	-	5



No.4706

Flush Fit Bolt Grip Fence Post Support to Bolt Down

A post support that works in the same way as a No. 4705 Bolt Down support, however this has a narrow oblong plate instead of the traditional square base that allows the support to be located close to a wall or structure.

Twin bolt fixing system is adjusted to hold the post firmly.

Bolt down using M12 Shield Anchors (6027/PP) or Concrete Bolts.

Code	Size	Finish	Box Qty	Ctn Qty
47060075BR	75mm 3" x 3"	Brown	-	10
47060100BR	100mm 4" x 4"	Brown	-	10
47060075GV	75mm 3" x 3"	Galv'd	-	10
47060100GV	100mm 4" x 4"	Galv'd	-	10



No.4707

Wedge Grip Fence Post Support to Bolt Down

A fence post support that has a wedge grip system that secures the posts firmly, gripping the wood as it is driven into the square hole. To be used on surfaces such as concrete, paving, brick or wood and protects the post base from insects, fungal and water.

Bolt down using M12 Shield Anchors (6027/PP) or Concrete Bolts.

Code	Size	Finish	Box Qty	Ctn Qty
47070075BR	75mm 3" x 3"	Brown	-	10
47070100BR	100mm 4" x 4"	Brown	-	10
47070075GV	75mm 3" x 3"	Galv'd	-	10
47070100GV	100mm 4" x 4"	Galv'd	-	10



AGRICULTURAL

GATE & SHED

FENCING & LANDSCAPING

DOMESTIC & INTERNAL

ARCHITECTURAL IRONMONGERY

WIRE FORMED PRODUCTS

PACKAGING OPTIONS

BESPOKE LASER CUTTING



No.4703

Fence Post Repair Spike

Used to repair damaged or rotten posts set directly into concrete bases without having to dig up the old concrete base. To use, cut off post at floor level and drive the spur into the wood that is set in the concrete.

Code	Size	Finish	Box Qty	Ctn Qty
47030075BR	75mm 3" x 3"	Brown	-	10
47030100BR	100mm 4" x 4"	Brown	-	10
47030075GV	75mm 3" x 3"	Galv'd	-	10
47030100GV	100mm 4" x 4"	Galv'd	-	10



No.4704

Bolt Grip Fence Post Support to Concrete In

To be inserted into a hole filled with concrete and provides a strong and stable base for the post

Twin bolt fixing system holds the posts firmly.

Code	Size	Finish	Box Qty	Ctn Qty
47040075BR	75mm 3" x 3"	Brown	-	10
47040100BR	100mm 4" x 4"	Brown	-	10
47040075GV	75mm 3" x 3"	Galv'd	-	10
47040100GV	100mm 4" x 4"	Galv'd	-	10



No.332

Standard Driving Tools

To help install 75mm x 75mm 3" x 3" drive - in post supports.

- Protects post support from damage

Code	Size	Finish	Box Qty	Ctn Qty
332-0000BK	75mm 3" x 3"	Black	-	5

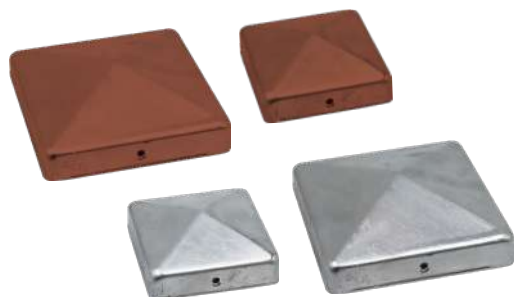

No.4730

Pyramid Metal Post Cap Finial

A decorative and protective piece that fits on top of a fence post helping to prevent the post from rotting or cracking by keeping water and insects away from the wood. It also adds a finishing touch to the fence and enhances its appearance.

Code	Size	Finish	Box Qty	Ctn Qty
47300075BR	75mm 3" x 3"	Brown	-	10
47300100BR	100mm 4" x 4"	Brown	-	10
47300075GV	75mm 3" x 3"	Galv'd	-	10
47300100GV	100mm 4" x 4"	Galv'd	-	10

No.4731

Ball Metal Post Cap Finial

A decorative and protective post cap with a ball shape.

Code	Size	Finish	Box Qty	Ctn Qty
47310075BR	75mm 3" x 3"	Brown	-	10
47310100BR	100mm 4" x 4"	Brown	-	10
47310075GV	75mm 3" x 3"	Galv'd	-	10
47310100GV	100mm 4" x 4"	Galv'd	-	10



No.8348

Solid Brass Rope Handrail Brackets

Best used with Decking Rope.

• Available in Polished Brass & Polished Chrome

Code	Size	Finish	Box Qty	Ctn Qty
8348-0024PB	24mm	Polished Brass	5	50
8348-0032PB	32mm	Polished Brass	5	50
8348-0024PC	24mm	Polished Chrome	5	50
8348-0032PC	32mm	Polished Chrome	5	50



No.8347

Solid Brass Rope Ends

Best used with Decking Rope.

• Available in Polished Brass & Polished Chrome

Code	Size	Finish	Box Qty	Ctn Qty
8347-0024PB	24mm	Polished Brass	5	50
8347-0032PB	32mm	Polished Brass	5	50
8347-0024PC	24mm	Polished Chrome	5	50
8347-0032PC	32mm	Polished Chrome	5	50

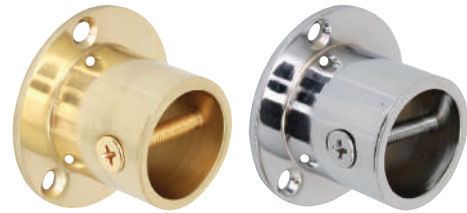

No.8349

Solid Brass Rope Hooks

Best used with Decking Rope.

• Available in Polished Brass & Polished Chrome

Code	Size	Finish	Box Qty	Ctn Qty
8349-0024PB	24mm	Polished Brass	5	50
8349-0032PB	32mm	Polished Brass	5	50
8349-0024PC	24mm	Polished Chrome	5	50
8349-0032PC	32mm	Polished Chrome	5	50



No.8350

Solid Brass Rope Eye Plates

Best used with Decking Rope.

• Available in Polished Brass & Polished Chrome

Code	Size	Finish	Box Qty	Ctn Qty
8350-0000PB	24mm/32mm	Polished Brass	5	50
8350-0000PC	24mm/32mm	Polished Chrome	5	50

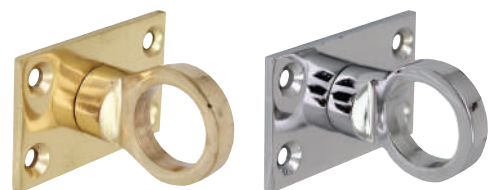

AGRICULTURAL

GATE & SHED

FENCING & LANDSCAPING

DOMESTIC & INTERNAL

ARCHITECTURAL IRONMONGERY

WIRE FORMED PRODUCTS

PACKAGING OPTIONS

BESPOKE LASER CUTTING

AGRICULTURAL



No.2006

12lb Post Maul with 36" Wooden Handle

Used for driving home fencing posts.

- With a cast iron head and 36" wooden handle

Code	Size	Finish	Box Qty	Ctn Qty
20060000BK	-	Black	-	1
20060000SC	-	Self Colour	-	1

GATE & SHED



No.487

Post Rammer

To suit 150mm 6" posts.

- Double handed

Code	Size	Finish	Box Qty	Ctn Qty
487-0150BK	150mm 6"	Black	-	1

FENCING & LANDSCAPING

DOMESTIC & INTERNAL



No.2013

Cable Laying Shovel

Code	Size	Finish	Box Qty	Ctn Qty
20130000BK	48"	Black	-	1

ARCHITECTURAL IRONMONGERY

WIRE FORMED PRODUCTS



No.2018

Fence Pliers

Code	Size	Finish	Box Qty	Ctn Qty
2018-0275BK	275mm	Black	6	18

PACKAGING OPTIONS

BESPOKE LASER CUTTING

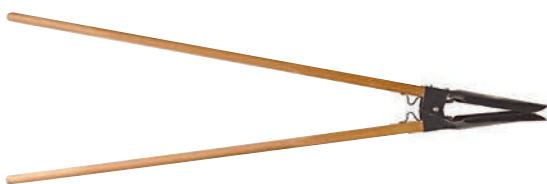

No.2000

Post Hole Digger with 48" Wooden Handle

Complete with 48" wooden handles.

Code	Size	Finish	Box Qty	Ctn Qty
20000000BK	48"	Black	-	1

No.2012

Square Mouth Shovel

Constructed of steel to give maximum strength.

- Multi-purpose general use
- Square blade maximises use and blade load

Code	Size	Finish	Box Qty	Ctn Qty
20120000BK	-	Black	-	1



No.2015

Newcastle Drainer Shovel

Steel construction designed for heavy duty and professional use.

- Steel Blade, Coated Steel Shaft Wooden Handle
- Blade Epoxy "hammered" Finish Coating, Rustproof Protection

Code	Size	Finish	Box Qty	Ctn Qty
20150000BK	-	Black	-	1



No.2003

Fencers Grafting Tool

This heavy-duty post hole digger comes with an angled, rounded blade and weighted steel.

- Efficient digging technique due to the angled, rounded head

Code	Size	Finish	Box Qty	Ctn Qty
20030000BK	-	Black	-	1



No.2014

Trenching Shovel

Long handle delivers greater leverage and extra reach for digging and clearing narrow trenches.

- Strong wooded shaft/handle for greater digging leverage
- Strong tempered carbon steel blade

Code	Size	Finish	Box Qty	Ctn Qty
20140000BK	-	Black	-	1



No.2002

Heavy Duty Shovel with Steel Handles

Complete with 54" steel handles.

- Use in heavy ground

Code	Size	Finish	Box Qty	Ctn Qty
20020000BK	54"	Black	-	1



No.2001

Shovel with Wooden Handles

Complete with 42" wooden handles.

- Digs minimum 10" diameter hole
- Unassemble to make two spades

Code	Size	Finish	Box Qty	Ctn Qty
20010000BK	42"	Black	-	1



AGRICULTURAL

GATE & SHED

FENCING & LANDSCAPING

DOMESTIC & INTERNAL

ARCHITECTURAL IRONMONGERY

WIRE FORMED PRODUCTS

PACKAGING OPTIONS

BESPOKE LASER CUTTING

AGRICULTURAL

GATE & SHED

FENCING & LANDSCAPING

DOMESTIC & INTERNAL

ARCHITECTURAL IRONMONGERY

WIRE FORMED PRODUCTS

PACKAGING OPTIONS

BESPOKE LASER CUTTING



No.472

Fence Panel Fixing Clips

For fixing light fence panels to wooden posts.

- To suit 38mm 1 1/2" timber

Code	Size	Finish	Box Qty	Ctn Qty
472-0000BR	40mm 1.6"	Brown	10	200
472-0000GV	40mm 1.6"	Pre-Galv'd	10	200



No.473

Fence Panel Fixing Clips

For fixing medium fence panels to wooden posts.

- To suit 44mm 1 3/4" timber

Code	Size	Finish	Box Qty	Ctn Qty
473-0000BR	46mm 1.8"	Brown	10	200
473-0000GV	46mm 1.8"	Pre-Galv'd	10	200



No.474

Fence Panel Fixing Clips

For fixing heavy fence panels to wooden posts.

- To suit 50mm 2" timber

Code	Size	Finish	Box Qty	Ctn Qty
474-0000BR	52mm 2.1"	Brown	10	200
474-0000GV	52mm 2.1"	Pre-Galv'd	10	200



No.1322

Panel Security Brackets for Concrete or Wooden Posts

A security product for connecting two fence panels between 100mm and 120mm posts.

Code	Size	Finish	Box Qty	Ctn Qty
13220000PG	-	Pre-Galv'd	-	25



No.477

Gravel Board Clips 250mm Long

Suitable for medium / heavy duty fence panels.

Code	Size	Finish	Box Qty	Ctn Qty
477-0000GV	50mm 2"	Pre-Galv'd	-	25

No.478

Gravel Board Clips with Retaining Lip for 50mm Timber

For attaching gravel boards to fence posts.

- Integral retaining lip

Code	Size	Finish	Box Qty	Ctn Qty
478-0150GV	150mm 6"	Pre-Galv'd	-	50
478-0230GV	230mm 9"	Pre-Galv'd	-	50



No.463

Two Pin Gravel Board Cleats

For attaching gravel boards to fence posts.

- Allows for a degree of adjustment after fitting
- 3 slots (6") / 6 slots (12")

Code	Size	Finish	Box Qty	Ctn Qty
463-0150GV	150mm 6"	Galv'd	5	40
463-0300GV	300mm 12"	Galv'd	5	20



No.460

Welded Barbed Wire Brackets - Side Fixing

The upper arm is 500mm 19 2/3" long and the lower arm is 230mm 9" long.

- Support bracket for barbed wire
- Support bracket for razor wire

Code	Size	Finish	Box Qty	Ctn Qty
460-0000GV	500mm x 230mm	Galv'd	-	10

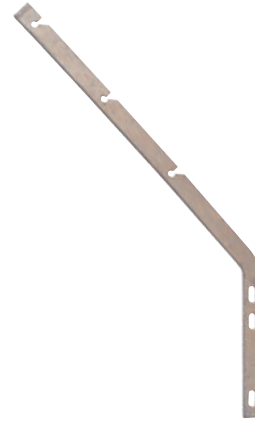

No.455

Welded Barbed Wire Brackets - Face Fixing

The upper arm is 416mm 16 1/3" long and the lower arm is 380mm 15" long.

- Support bracket for barbed wire
- Support bracket for razor wire

Code	Size	Finish	Box Qty	Ctn Qty
455-0000GV	416mm x 380mm	Galv'd	-	10



No.456

Barbed Wire Spacers with 150mm & 200mm Hole Spacing

Designed to separate and equally space barbed wire.

- Manufactured from 25mm x 5mm steel

Code	Size	Finish	Box Qty	Ctn Qty
456-0360GV	360mm	Galv'd	-	20
456-0460GV	460mm	Galv'd	-	20



AGRICULTURAL

GATE & SHED

FENCING & LANDSCAPING

DOMESTIC & INTERNAL

ARCHITECTURAL IRONMONGERY

WIRE FORMED PRODUCTS

PACKAGING OPTIONS

BESPOKE LASER CUTTING

AGRICULTURAL

GATE & SHED

FENCING & LANDSCAPING

DOMESTIC & INTERNAL

ARCHITECTURAL IRONMONGERY

WIRE FORMED PRODUCTS

PACKAGING OPTIONS

BESPOKE LASER CUTTING



No.475

Arris Rail Repair Brackets for 75mm 3" Timber

Used to install/repair broken 75mm 3" Arris Rail.

Code	Size	Finish	Box Qty	Ctn Qty
475-0220BR	220mm 8.8"	Brown	-	20
475-0100GV	100mm 4"	Pre-GalVd	-	20
475-0220GV	220mm 8.8"	Pre-GalVd	-	20
475-0300GV	300mm 12"	Pre-GalVd	-	20

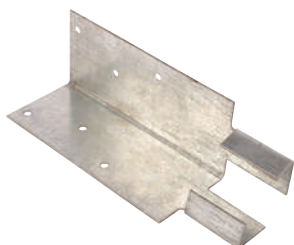

No.483

Arris Rail Mortice Brackets

For fixing Arris Rails directly into morticed concrete posts.

Code	Size	Finish	Box Qty	Ctn Qty
483-0000GV	-	GalVd	-	25

Left Hand



Right Hand

No.484

Arris Rail Support Brackets - Bolt on Type

A unique product specially designed for supporting Arris Rails.

Code	Size	Finish	Box Qty	Ctn Qty
484-0000GVLH	-	Pre-GalVd	-	25
484-0000GVRH	-	Pre-GalVd	-	25



No.481/WH

Birds Mouth Post Straps - One Bend

For attaching fence rails to birds mouth posts.

• 1 bend post rail strap.

Code	Size	To Suit	Finish	Box Qty	Ctn Qty
481WH070GV	70mm	3" Posts	Pre-GalVd	-	25
481WH090GV	90mm	4" Posts	Pre-GalVd	-	25



No.480

Birds Mouth Post Straps - Three Bend

For attaching fence rails to birds mouth posts.

• 3 bend post rail strap.

Code	Size	To Suit	Finish	Box Qty	Ctn Qty
480-0070GV	70mm	3" Rail, 4" Post	Pre-GalVd	-	25
480-0095GV	95mm	4" Rail, 6" Post	Pre-GalVd	-	25



No.482

Birds Mouth Post Straps - Five Bend for 4" x 4" Posts

For attaching fence rails to birds mouth posts.

• 5 bend post rail strap.

Code	Size	Finish	Box Qty	Ctn Qty
482-0000GV	100mm	Pre-GalVd	-	25

No.426

Ferrule Locking Strainers

For straining wire to prevent sagging.

- Post fitting

Code	Size	Finish	Box Qty	Ctn Qty
426-0000GV	90mm 3½"	Galv'd	-	25

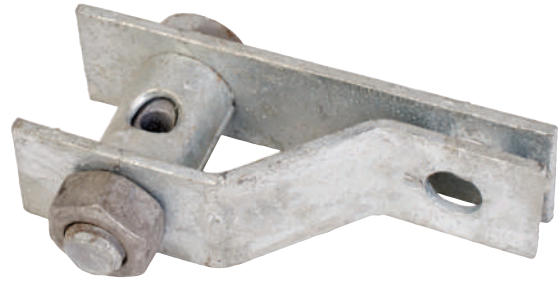

No.427

Ratchet Strainers

To suit 3mm/4mm diameter mild steel or high tensile wire.

- Post fitting
- Commonly used in Ireland
- Suits 10mm diameter fencing eyebolts

Code	Size	Finish	Box Qty	Ctn Qty
427-0000GV	10mm 3/8"	Galv'd	-	25



No.428

Large Radisseurs

To suit 3mm/4mm diameter mild steel or high tensile wire.

- None post fitting
- Commonly used in Scotland

Code	Size	Finish	Box Qty	Ctn Qty
428-0000GV	120mm 4¾"	Galv'd	-	25



No.429

Small Radisseurs

For straining wire to prevent sagging.

- Complete with Ratchet locking system

Code	Size	Finish	Box Qty	Ctn Qty
429-0000GV	100mm 4"	Galv'd	-	25



AGRICULTURAL

GATE & SHED

FENCING & LANDSCAPING

DOMESTIC & INTERNAL

ARCHITECTURAL IRONMONGERY

WIRE FORMED PRODUCTS

PACKAGING OPTIONS

BESPOKE LASER CUTTING



No.465

Stretcher Bars

Use in conjunction with angle cleats to hold chain link fencing firm between posts.

- Manufactured from 20mm x 5mm steel
- 2 slots and 3 slots

Code	Size	Finish	Box Qty	Ctn Qty
465-0900GV2	900mm 36"	Galv'd	-	10
465-0900GV3	900mm 36"	Galv'd	-	-
465-1200GV	1200mm 48"	Galv'd	-	10
465-1800GV	1800mm 72"	Galv'd	-	-
465-1800GV25	1800mm 72"	Galv'd	-	5



No.462

Angle Cleats

For use in conjunction with stretcher bars to provide a straight and even run.

- Manufactured from 5mm and 6mm steel

Code	Size	Finish	Box Qty	Ctn Qty
462-0038GV	38mm x 38mm x 32mm	Galv'd	-	100
462-0040GV	40mm x 40mm x 40mm	Galv'd	-	100
462-0050GV	50mm x 50mm x 50mm	Galv'd	-	50
462-0076GV	75mm x 50mm x 50mm	Galv'd	-	50
462-0125GV	125mm x 50mm x 50mm	Galv'd	-	30



No.458

Stretcher Bar Lugs to Weld with 11 Diameter Hole

An alternative for securing stretcher bars.

- Manufactured from 25mm x 5mm steel

Code	Size	Finish	Box Qty	Ctn Qty
458-0030SC	30mm x 25mm x 5mm	Self Colour	200	800
458-0052SC	50mm x 25mm x 5mm	Self Colour	20	200



No.414

Rabbit Netting / Tent Pegs

Ideal for securing rabbit netting, tents and ground sheets etc.

- Ground marker to locate moles

Code	Size	Finish	Box Qty	Ctn Qty
414-0150GV	150mm 6"	Galv'd	20	200
414-0300GV	300mm 12"	Galv'd	20	140



No.412

Vine Eyes to Screw

Used for general purposes and training plants utilizing threaded wire.

Code	Size	Finish	Box Qty	Ctn Qty
412-0075ZP	75mm 3"	BZP-E/Galv	50	500
412-0100ZP	100mm 4"	BZP-E/Galv	50	500
412-0125ZP	125mm 5"	BZP-E/Galv	50	500
412-0150ZP	150mm 6"	BZP-E/Galv	50	500

No.452

Welded Eye Bolts c/w 2 Nuts & 2 Washers

Suitable for fencing or trellis construction.

- Post connection for line wire

Code	Size	Finish	Box Qty	Ctn Qty
452-0150ZP	150mm 6" x 3/8"	BZP-E/Galv	10	100
452-0200ZP	200mm 8" x 3/8"	BZP-E/Galv	10	100
452-0250ZP	250mm 10" x 3/8"	BZP-E/Galv	10	100
452-0300ZP	300mm 12" x 3/8"	BZP-E/Galv	10	80
452-0150GV	150mm 6" x 3/8"	Galv'd	10	100
452-0200GV	200mm 8" x 3/8"	Galv'd	10	100
452-0250GV	250mm 10" x 3/8"	Galv'd	10	100
452-0300GV	300mm 12" x 3/8"	Galv'd	10	80



No.453

Unwelded Eye Bolts c/w 2 Nuts & 2 Washers

Unwelded Eye Bolts comes with 2 nuts & 2 washers.

- Post connection for wire mesh/netting

Code	Size	Finish	Box Qty	Ctn Qty
453-0150ZP	150mm 6" x 3/8"	BZP-E/Galv	10	100
453-0200ZP	200mm 8" x 3/8"	BZP-E/Galv	10	100
453-0250ZP	250mm 10" x 3/8"	BZP-E/Galv	10	100
453-0300ZP	300mm 12" x 3/8"	BZP-E/Galv	10	80



No.411

Vine Eyes to Drive

Inserted into brickwork and used to secure vines and plants to walls with threaded wire.

Code	Size	Finish	Box Qty	Ctn Qty
411-0075ZP	75mm 3"	BZP-E/Galv	100	500
411-0100ZP	100mm 4"	BZP-E/Galv	100	500
411-0125ZP	125mm 5"	BZP-E/Galv	100	500
411-0150ZP	150mm 6"	BZP-E/Galv	100	500



No.408

Gate Staples 7mm

For general use within the agricultural/fencing industries.

- Use with gate drops

Code	Size	Finish	Box Qty	Ctn Qty
408-0063GV	63mm 2½"	Galv'd	20	200
408-0075GV	75mm 3"	Galv'd	20	200
408-0100GV	100mm 4"	Galv'd	20	200



AGRICULTURAL

GATE & SHED

FENCING & LANDSCAPING

DOMESTIC & INTERNAL

ARCHITECTURAL IRONMONGERY

WIRE FORMED PRODUCTS

PACKAGING OPTIONS

BESPOKE LASER CUTTING

Steel Fencing System



Steel Post Fencing System

The UKANDIN Steel Post Fencing System has been designed as a simple, cost effective alternative to wooden fencing systems. The system is compatible with C8, HT8 and FX8 stockfence, as well as having 2 hole positions for Barbed Wire.

- 25 Year minimum life expectancy
- Fully configurable to suit customer requirements
- Unique, simple to install design
- CUSTOMISE ANY PART OF THE SYSTEM TO SUIT YOUR CUSTOMER MARKET



Steel Support Struts

The struts easily fit into the holes without the need for tools. These can be positioned to 3 different heights, depending on your choice of installation fence height.



Steel Base Plates

The Struts of your Fencing System need support to stay in place. The UKANDIN Fencing System offers a dual purpose base plate with a drive-in security pin:

- Suitable for Soft and Hard Ground
- Drive-in Security Pin included

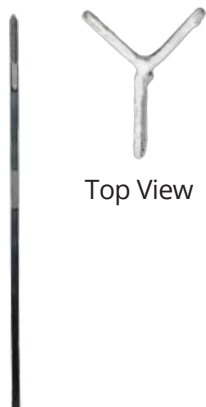

Top View

No.4725 Steel Intermediate Posts

Intermediate Posts are usually fitted 2m apart. Thanks to the Y Shaped Profile of these posts, there is no need to dig holes or set concrete bases – simply drive them into the ground. Each post has a designed plate installed on the bottom, ensuring the post will not up from the ground once installed.

- Y Shaped Profile offers maximum strength
- Easy to install, simple, drive in solution
- Unique plate prevents the post being pulled out



No.4726

Steel Fence Post Clips

These clips are used to join the mesh fencing to the UKANDIN Steel Post Fencing System. Standard Fence Clip Pliers can be used, or for best results, use the UKANDIN Fencing System Clip Pliers.



No.2162

Fencing Pliers

Installation becomes easy when you use the right tools. These Pliers have been uniquely designed to work effortlessly with the UKANDIN Fencing System Post Clips.

- Increase installation speed by up to 50%



DOMESTIC & INTERNAL

Plates & Braces	66	Hooks & Fittings	72
Shelf & Handrail Brackets	68	Pulleys	74
Door Bolts	70		



No.315

Stretcher Plates

Ideal for fitting cupboard units.

- Use where joining or strengthening is required
- Steel construction

Code	Size	Finish	Box Qty	Ctn Qty
315-0000ZP	-	BZP-E/Galv	100	700
315-0000SC	-	Self Colour	100	700

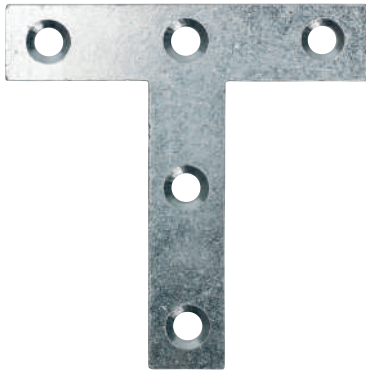

No.318

Tee Plates

The 3" Tee Plates are 16.25mm wide whilst the 4" version is 19.4mm wide.

Code	Size	Finish	Box Qty	Ctn Qty
318-0075ZP	75mm 3"	BZP-E/Galv	25	500
318-0100ZP	100mm 4"	BZP-E/Galv	25	250

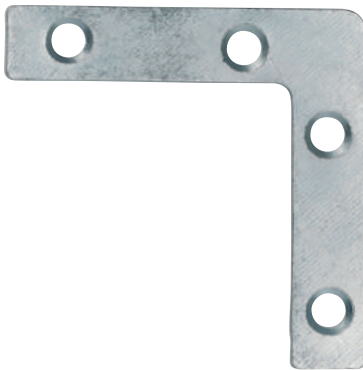

No.324

Corner Plates

Code	Size	Finish	Box Qty	Ctn Qty
324-0050ZP	50mm 2"	BZP-E/Galv	50	1000
324-0063ZP	63mm 2½"	BZP-E/Galv	50	750
324-0075ZP	75mm 3"	BZP-E/Galv	50	400
324-0100ZP	100mm 4"	BZP-E/Galv	25	300



No.325

Mending Plates

Code	Size	Finish	Box Qty	Ctn Qty
325-0075ZP	75mm 3"	BZP-E/Galv	50	700
325-0100ZP	100mm 4"	BZP-E/Galv	50	400
325-0125ZP	125mm 5"	BZP-E/Galv	25	300
325-0150ZP	150mm 6"	BZP-E/Galv	25	200
325-0075SC	75mm 3"	Self Colour	50	700
325-0100SC	100mm 4"	Self Colour	50	400
325-0125SC	125mm 5"	Self Colour	25	300
325-0150SC	150mm 6"	Self Colour	25	200

No.320

Corner Braces

Countersunk inside only.

Code	Size	Finish	Box Qty	Ctn Qty
320-0025ZP	25mm 1"	BZP-E/Galv	50	1500
320-0038ZP	38mm 1½"	BZP-E/Galv	50	1000
320-0050ZP	50mm 2"	BZP-E/Galv	50	700
320-0063ZP	63mm 2½"	BZP-E/Galv	50	500
320-0075ZP	75mm 3"	BZP-E/Galv	50	250
320-0100ZP	100mm 4"	BZP-E/Galv	25	200
320-0125ZP	125mm 5"	BZP-E/Galv	25	150
320-0150ZP	150mm 6"	BZP-E/Galv	25	100
320-0025SC	25mm 1"	Self Colour	50	1500
320-0038SC	38mm 1½"	Self Colour	50	1000
320-0050SC	50mm 2"	Self Colour	50	700
320-0063SC	63mm 2½"	Self Colour	50	500
320-0075SC	75mm 3"	Self Colour	50	250
320-0100SC	100mm 4"	Self Colour	25	200
320-0125SC	125mm 5"	Self Colour	25	150
320-0150SC	150mm 6"	Self Colour	25	100



No.297

Extension Base Bracket

Primarily designed for use with Y Type Clips, these multi-functional brackets can be used to attach steel cable ties or fire rated cable retaining clips for wiring, CCTV camera supports, flue pipes.

- Multifunctional
- Can be cut to length required

Code	Size	Finish	Box Qty	Ctn Qty
297-0250GV	250mm 10"	Galv'd	10	50



No.241

Weather Bars

Set into concrete and used to prevent rainwater penetrating under a wooden exterior entrance door.

- Longer lengths can be supplied

Code	Size	Finish	Box Qty
241-1030GV	1m x 30mm x 6mm	Galv'd	50



No.499

Steel Timber Dogs (12mm diameter)

Steel Timber Dog also known as a Staple Pin.

- For connecting or moving large pieces of timber such as Joists and Sleepers

Code	Size	Finish	Box Qty	Ctn Qty
499-0150GV	150mm 6"	Galv'd	10	40



UKANDIN IN HOUSE MANUFACTURING CAPABILITY

Pressed Steel & Aluminium • Forged Steel & Brass
Casting • Thread Rolling • Wire Forming
Injection Moulding • Finishing • Laser Cutting





No.240

London Shelf Brackets

The most popular bracket used for light and medium shelving.

Code	Size	Finish	Box Qty	Ctn Qty
240-0100GR	100mm 4" x 3"	Grey	20	240
240-0125GR	125mm 5" x 4"	Grey	20	240
240-0150GR	150mm 6" x 5"	Grey	20	240
240-0200GR	200mm 8" x 6"	Grey	20	160
240-0225GR	225mm 9" x 7"	Grey	20	140
240-0250GR	250mm 10" x 8"	Grey	20	140
240-0300GR	300mm 12" x 10"	Grey	20	80
240-0350GR	350mm 14" x 12"	Grey	20	60
240-0100WH	100mm 4" x 3"	White	20	240
240-0125WH	125mm 5" x 4"	White	20	240
240-0150WH	150mm 6" x 5"	White	20	240
240-0200WH	200mm 8" x 6"	White	20	160
240-0225WH	225mm 9" x 7"	White	20	140
240-0250WH	250mm 10" x 8"	White	20	140
240-0300WH	300mm 12" x 10"	White	20	80
240-0350WH	350mm 14" x 12"	White	20	60



No.244

Ornamental Scroll Shelf Brackets

Excellent for hanging baskets.

• Can be used as a shelving bracket

Code	Size	Finish	Box Qty	Ctn Qty
244-0150BK	150mm 6"	Black	10	80
244-0200BK	200mm 8"	Black	10	60
244-0250BK	250mm 10"	Black	10	60
244-0150WH	150mm 6"	White	10	80
244-0200WH	200mm 8"	White	10	60
244-0250WH	250mm 10"	White	10	60



No.247

Fluted Angle Brackets

A multi-purpose product.

• Popular for use in the plumbing and associated trades

Code	Size	Finish	Box Qty	Ctn Qty
247-0075GV	75mm 3" x 2mm	Galv'd	20	140
247-0100GV	100mm 4" x 3mm	Galv'd	20	140
247-0125GV	125mm 5" x 4mm	Galv'd	20	80
247-0150GV	150mm 6" x 5mm	Galv'd	20	60
247-0200GV	200mm 8" x 6mm	Galv'd	20	20
247-0250GV	250mm 10" x 8mm	Galv'd	20	20
247-0300GV	300mm 12" x 10mm	Galv'd	20	20

No.422

Stay Brackets

Ideal for supporting large shelves.

- Excellent where strong support is required

Code	Size	Finish	Box Qty	Ctn Qty
422-0400GR	400mm 16" x 14mm	Grey	-	10
422-0450GR	450mm 18" x 16mm	Grey	-	10



No.234

Solid Brass Handrail Brackets

Premium quality solid brass, cast handrail bracket.

- Dimension is projection from wall

Code	Size	Finish	Box Qty	Ctn Qty
234-0065PB	63mm 2½"	Polished Brass	5	40



No.236

Handrail Brackets

The most popular product for use on handrails.

- Dimension is projection from wall

Code	Size	Finish	Box Qty	Ctn Qty
236-0063BK	63mm 2½"	Black	10	100
236-0063ZP	63mm 2½"	BZP-E/Galv	10	100
236-0075ZP	75mm 3"	BZP-E/Galv	10	100
236-0063GR	63mm 2½"	Grey	10	100
236-0050WH	50mm 2"	White	15	120
236-0063WH	63mm 2½"	White	10	100
236-0075WH	75mm 3"	White	10	100



No.964

Aluminium Handrail Brackets

High quality aluminium handrail bracket suitable for timber and steel balustrades.

- Dimension is projection from wall

Code	Size	Finish	Box Qty	Ctn Qty
964-0063AL	63mm 2½"	Aluminium	10	100



AGRICULTURAL

GATE & SHED

FENCING & LANDSCAPING

DOMESTIC & INTERNAL

ARCHITECTURAL IRONMONGERY

WIRE FORMED PRODUCTS

PACKAGING OPTIONS

BESPOKE LASER CUTTING



No.60MT

Monkey Tail Bolts

A multi-purpose door or gate bolt.

- Shaped handle

Code	Size	Finish	Box Qty	Ctn Qty
60MT0300BK	300mm 12"	Black	-	5
60MT0380BK	380mm 15"	Black	-	5
60MT0450BK	450mm 18"	Black	-	5
60MT0600BK	600mm 24"	Black	-	5
60MT0300GV	300mm 12"	Galv'd	-	5
60MT0380GV	380mm 15"	Galv'd	-	5
60MT0450GV	450mm 18"	Galv'd	-	5
60MT0600GV	600mm 24"	Galv'd	-	5



No.60BH

Bow Handle Bolts

A multi-purpose door or gate bolt.

- Fitted with an easy grip bow handle

Code	Size	Finish	Box Qty	Ctn Qty
60BH0300BK	300mm 12"	Black	-	5
60BH0380BK	380mm 15"	Black	-	5
60BH0450BK	450mm 18"	Black	-	5
60BH0600BK	600mm 24"	Black	-	5
60BH0300GV	300mm 12"	Galv'd	-	5
60BH0380GV	380mm 15"	Galv'd	-	5
60BH0450GV	450mm 18"	Galv'd	-	5
60BH0600GV	600mm 24"	Galv'd	-	5



No.68

Foot Bolt

Used to secure the bottom of a door or gate to the floor. Foot operated.

Code	Size	Finish	Box Qty	Ctn Qty
68--0000BK	200mm 8"	Black	-	10
68--0000ZP	200mm 8"	BZP-E/Galv	-	10



No.66

Chain Bolt

Used to secure the top of a door or gate to the jamb. Hand operated.

- Chain length is 400mm

Code	Size	Finish	Box Qty	Ctn Qty
66--0000BK	200mm 8"	Black	-	10
66--0000ZP	200mm 8"	BZP-E/Galv	-	10

LOOKING FOR DROP BOLTS?

From Garage Door Drop Bolts to Heavy Surface Bolts, see the full range on page 39



No.584

Receiver Plates for Square Bolts

• Fixes to underside of door jamb and can be flush fitted

Code	Size	Finish	Box Qty	Ctn Qty
584-0000ZP	16mm	BZP-E/Galv	10	200

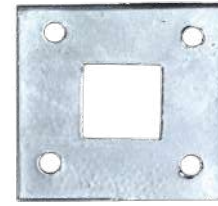

No.70

Solid Brass Barrel Bolts 1" Wide

Supplied polished & lacquered including brass wood screws.

Code	Size	Finish	Box Qty	Ctn Qty
70-0075PB	75mm 3"	Polished Brass	10	100
70-0100PB	100mm 4"	Polished Brass	10	100
70-0075PC	75mm 3"	Polished Chrome	10	100
70-0100PC	100mm 4"	Polished Chrome	10	100



No.80

Solid Brass Necked Barrel Bolts 1" Wide

Supplied polished & lacquered including brass wood screws.

Code	Size	Finish	Box Qty	Ctn Qty
80-0075PB	75mm 3"	Polished Brass	-	10
80-0075PC	75mm 3"	Polished Chrome	-	10



No.71

Aluminium Barrel Bolts 1" Wide

Code	Size	Finish	Box Qty	Ctn Qty
71-0075AL	75mm 3"	Satin	10	200
71-0100AL	100mm 4"	Satin	10	200



No.73

Aluminium Necked Barrel Bolts 1" Wide

Code	Size	Finish	Box Qty	Ctn Qty
73-0075AL	75mm 3"	Satin	10	200

**Solid Brass Surface Door Bolts/Glide Bolts**

Code	Size	Finish	Box Qty	Ctn Qty
671-0100PB	100mm 4"	Polished Brass	5	50
671-0100PC	100mm 4"	Polished Chrome	5	50

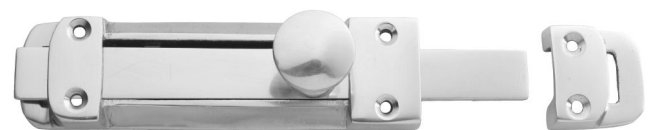



No.246

Heavy Chest Handles

A strong product for general use in heavier weight applications.
 • 1 piece construction

Code	Size	Finish	Box Qty	Ctn Qty
246-0000BK	100mm 4"	Black	5	25



No.1031

Aluminium Hat & Coat Hooks c/w Screws

For hanging hats and coats.

Code	Size	Finish	Box Qty	Ctn Qty
10310000AL	125mm 5"	Aluminium	20	500



No.1012

Junior Reliance Door Holders

Suitable for fitting to the underside of lintel on lightweight single doors or out buildings.

• The overall length of the door holder is 15"

Code	Size	Finish	Box Qty	Ctn Qty
10120000BK	-	Black	-	1



No.1010

Senior Reliance Door Holders

Suitable for fitting to the underside of a wide lintel.

• The overall length of the door holder is 24"

Code	Size	Finish	Box Qty	Ctn Qty
10100000BK	-	Black	-	1



No.1011

Senior Reliance Door Holders - Narrow Lintel

Suitable for fitting to the underside of a narrow lintel.

• The overall length of the door holder is 24"

Code	Size	Finish	Box Qty	Ctn Qty
10110000BK	-	Black	-	1

AGRICULTURAL

GATE & SHED

FENCING & LANDSCAPING

DOMESTIC & INTERNAL

ARCHITECTURAL IRONMONGERY

WIRE FORMED PRODUCTS

PACKAGING OPTIONS

BESPOKE LASER CUTTING

No.413

Ceiling Hooks to Screw

A multi-purpose hook designed for lightweight loads.
• Should not be used for lifting purposes

Code	Size	Finish	Box Qty	Ctn Qty
413-0075ZP	75mm 3"	BZP-E/Galv	25	200
413-0100ZP	100mm 4"	BZP-E/Galv	25	200



No.415

Screw Eyes

A multi-purpose hook designed for lightweight loads.
• Should not be used for lifting purposes

Code	Size	Finish	Box Qty	Ctn Qty
415-0045ZP	45mm x 10mm	BZP-E/Galv	100	-
415-0065ZP	65mm x 14mm	BZP-E/Galv	100	-



No.299

Cleat Hooks

Ideal for securing rope to walls and other surfaces.
• Steel

Code	Size	Finish	Box Qty	Ctn Qty
299-0100BK	100mm 4"	Black	25	250
299-0100ZP	100mm 4"	BZP-E/Galv	25	250
299-0100GV	100mm 4"	Galv'd	25	250
299-0125GV	125mm 5"	Galv'd	25	150
299-0150GV	150mm 6"	Galv'd	25	100
299-0100WH	100mm 4"	White	25	250



No.1518

S Hooks with Ball End

A shaped hook designed to fit over clothes airer laths.
• Ball ended to avoid sagging

Code	Size	Finish	Box Qty	Ctn Qty
15180100CH	100mm	Chrome	10	500



No.1508

Super Six Rack Ends

Used to create 6 lath clothes airers. Commonly used with pulley systems.

Code	Size	Finish	Box Qty	Ctn Qty
15080000BK	-	Black	5	20
15080000WH	-	White	5	20



No.1510

Traditional Rack End

Used to create 4 lath clothes airers. Commonly used with pulley systems.

Code	Size	Finish	Box Qty	Ctn Qty
15100000BK	-	Black	10	40
15100000WH	-	White	10	40



AGRICULTURAL

GATE & SHED

FENCING & LANDSCAPING

DOMESTIC & INTERNAL

ARCHITECTURAL IRONMONGERY

WIRE FORMED PRODUCTS

PACKAGING OPTIONS

BESPOKE LASER CUTTING



No.41

Single Screw Cast Pulley - Nylon Wheel

White finish has white nylon wheels, all other finishes have grey nylon wheels.
 • Nylon wheel

Code	Size	Finish	Box Qty	Ctn Qty
41-0000BK	44mm	Black	10	100
41-0000WH	44mm	White	10	100



No.41/C

Single Screw Cast Pulley - BZP Cast Wheel

Bright zinc plating cast wheel version of the version above.
 • BZP cast wheel

Code	Size	Finish	Box Qty	Ctn Qty
41C-0000BK	44mm	Black	10	100
41C-0000WH	44mm	White	10	100



No.42

Double Screw Cast Pulley - Nylon Wheel

White finish has white nylon wheels, all other finishes have grey nylon wheels.
 • Nylon wheel

Code	Size	Finish	Box Qty	Ctn Qty
42-0000BK	44mm	Black	10	60
42-0000WH	44mm	White	10	60



No.42/C

Double Screw Cast Pulley - BZP Cast Wheel

White finish has white nylon wheels, all other finishes have grey nylon wheels.
 • Nylon wheel

Code	Size	Finish	Box Qty	Ctn Qty
42C-0000BK	44mm	Black	10	60
42C-0000WH	44mm	White	10	60

AGRICULTURAL

GATE & SHED

FENCING & LANDSCAPING

DOMESTIC & INTERNAL

ARCHITECTURAL IRONMONGERY

WIRE FORMED PRODUCTS

PACKAGING OPTIONS

BESPOKE LASER CUTTING

No.1260

Single Line Cast Pulley with Hook - Nylon Wheel

Ideal for raising or lowering lightweight objects.

Code	Size	Finish	Box Qty	Ctn Qty
12600038BK	38mm	Black	10	60
12600038GV	38mm	Galv'd	10	60



No.1260

No.1260/C



No.1260/C

Single Line Cast Pulley with Hook - BZP Cast Wheel

Ideal for raising or lowering lightweight objects.

- Maximum rope size - 8mm

Code	Size	Finish	Box Qty	Ctn Qty
1260C038GV	38mm	Galv'd	10	60

No.261

Single Awning Cast Pulley - Nylon Wheel

Suitable for use with awnings and when raising or lowering lightweight objects.

- Can be used when erecting tarpaulins

Code	Size	Finish	Box Qty	Ctn Qty
261-0038BK	38mm	Black	10	100
261-0050BK	50mm	Black	10	60



No.261

No.261/C



No.261/C

Single Awning Cast Pulley - BZP Cast Wheel

Suitable for use with awnings and when raising or lowering lightweight objects.

- Can be used when erecting tarpaulins

Code	Size	Finish	Box Qty	Ctn Qty
261C0038GV	38mm	Galv'd	10	100

No.269

Double Upright Cast Pulley 38mm Nylon Wheel Along the Plate

Ideal for raising or lowering lightweight objects.

- Suitable for most washing lines
- Vertical or horizontal

Code	Size	Finish	Box Qty	Ctn Qty
269-0000BK	38mm	Black	10	60



No.31

Side Cast Pulleys - Nylon Wheels

Ideal for raising or lowering lightweight objects.

Code	Size	Finish	Box Qty	Ctn Qty
31-0000BK	38mm 1½"	Black	10	100



AGRICULTURAL

GATE & SHED

FENCING & LANDSCAPING

DOMESTIC & INTERNAL

ARCHITECTURAL IRONMONGERY

WIRE FORMED PRODUCTS

PACKAGING OPTIONS

BESPOKE LASER CUTTING

AGRICULTURAL

GATE & SHED

FENCING & LANDSCAPING

DOMESTIC & INTERNAL

ARCHITECTURAL IRONMONGERY

WIRE FORMED PRODUCTS

PACKAGING OPTIONS

BESPOKE LASER CUTTING



No.264



No.264/C

No.264

Upright Cast Pulley 38mm Nylon Wheel Across the Plate

Ideal for raising or lowering lightweight objects.

- Suitable for most washing lines
- Vertical or horizontal

Code	Size	Finish	Box Qty	Ctn Qty
264-0000BK	38mm	Black	10	100

No.264/C

Upright Cast Pulley 38mm BZP Cast Wheel Across the Plate

Ideal for raising or lowering lightweight objects.

- Suitable for most washing lines
- Vertical or horizontal

Code	Size	Finish	Box Qty	Ctn Qty
264C0000GV	38mm	Galv'd	10	100



No.268



No.268/C

No.268

Upright Cast Pulley 38mm Nylon Wheel Along the Plate

Ideal for raising or lowering lightweight objects.

- Suitable for most washing lines
- Vertical or horizontal

Code	Size	Finish	Box Qty	Ctn Qty
268-0000BK	38mm	Black	10	100

No.268/C

Upright Cast Pulley 38mm BZP Cast Wheel Along the Plate

Ideal for raising or lowering lightweight objects.

- Suitable for most washing lines
- Vertical or horizontal

Code	Size	Finish	Box Qty	Ctn Qty
268C0000GV	38mm	Galv'd	10	100



ARCHITECTURAL IRONMONGERY

Light Butt Hinges	78	Window & Furniture Hinges	83
Medium Butt Hinges	80	Old Hill Ironworks - Premium Black Ironmongery	85
Strong Butt Hinges	81	The Forge Black Ironwork	104
Weldable Hinges	82		

AGRICULTURAL

GATE & SHED

FENCING & LANDSCAPING

DOMESTIC & INTERNAL

ARCHITECTURAL IRONMONGERY

WIRE FORMED PRODUCTS

PACKAGING OPTIONS

BESPOKE LASER CUTTING

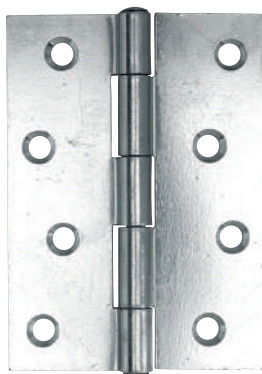

No.1838

Light Butt Hinges

The most commonly used butt hinge in the home.

- Rigid type hinge
- Pin cannot be removed
- Cranked knuckle

Code	Size	Finish	Box Qty	Ctn Qty
18380025ZP	25mm 1"	BZP-E/Galv	25	500
18380038ZP	38mm 1½"	BZP-E/Galv	10	400
18380050ZP	50mm 2"	BZP-E/Galv	10	250
18380063ZP	63mm 2½"	BZP-E/Galv	10	160
18380075ZP	75mm 3"	BZP-E/Galv	10	120
18380090ZP	90mm 3½"	BZP-E/Galv	10	70
18380100ZP	100mm 4"	BZP-E/Galv	5	60
18380075CH	75mm 3"	Chrome	10	120
18380050EB	50mm 2"	Electro Brass	10	250
18380063EB	63mm 2½"	Electro Brass	10	160
18380075EB	75mm 3"	Electro Brass	10	120
18380100EB	100mm 4"	Electro Brass	5	60
18380025SC	25mm 1"	Self Colour	25	500
18380038SC	38mm 1½"	Self Colour	10	400
18380050SC	50mm 2"	Self Colour	10	250
18380063SC	63mm 2½"	Self Colour	10	160
18380075SC	75mm 3"	Self Colour	10	120
18380090SC	90mm 3½"	Self Colour	10	70
18380100SC	100mm 4"	Self Colour	5	60



No.1838/SS

Stainless Steel Light Butt Hinges

The most commonly used butt hinge in the home.

- Rigid type hinge
- Pin cannot be removed
- Cranked knuckle
- Grade 201 higher corrosion resistance

Code	Size	Finish	Box Qty	Ctn Qty
18380075SS	75mm 3"	Stainless Steel	10	120
18380100SS	100mm 4"	Stainless Steel	5	60



No.1838CC

Light Butt Hinges - Powder Coated

The most commonly used butt hinge in the home.

- Rigid type hinge
- Pin cannot be removed
- Cranked knuckle
- Colour consistent

Code	Size	Finish	Box Qty	Ctn Qty
1838CC0075BK	75mm 3"	Black	10	100
1838CC0100BK	100mm 4"	Black	5	40

UKANDIN IN HOUSE MANUFACTURING CAPABILITY

- Pressed Steel & Aluminium • Forged Steel & Brass
 Casting • Thread Rolling • Wire Forming
 Injection Moulding • Finishing • Laser Cutting



No.1838T

Light Narrow Butt Hinges - No Holes

A multi-purpose hinge often welded onto tool boxes etc.

- Pin cannot be removed
- No holes

Code	Size	Finish	Box Qty	Ctn Qty
1838T075SC	75mm 3"	Self Colour	10	120
1838T100SC	100mm 4"	Self Colour	5	60



No.1840

Light Butt Hinges - Loose Pin

The door can be unhinged without removing the hinge.

- General purpose use
- Removable pin

Code	Size	Finish	Box Qty	Ctn Qty
18400090BK	90mm 3½"	Black	10	70
18400075ZP	75mm 3"	BZP-E/Galv	10	120
18400090ZP	90mm 3½"	BZP-E/Galv	10	70
18400100ZP	100mm 4"	BZP -E/Galv	5	60
18400100CH	100mm 4"	Chrome	5	60
18400090EB	90mm 3½"	Electro Brass	10	70
18400100EB	100mm 4"	Electro Brass	5	60

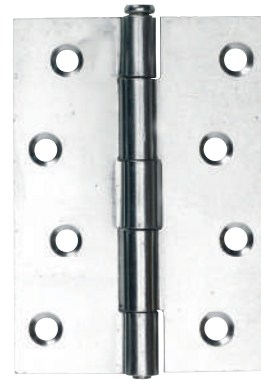

No.1840R

Light Butt Hinges - Loose Pin & Radius Corner

The door can be unhinged without removing the hinge.

- General purpose use
- Removable pin

Code	Size	Finish	Box Qty	Ctn Qty
1840R075ZP	75mm 3"	BZP-E/Galv	10	120
1840R100ZP	100mm 4"	BZP-E/Galv	5	60

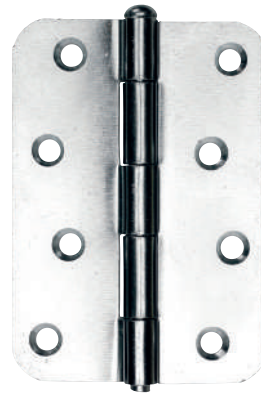

No.5050

Light Narrow Butt Hinges

Suitable for lightweight cupboard doors.

- Rigid type hinge
- Pin cannot be removed
- Uncranked knuckle

Code	Size	Finish	Box Qty	Ctn Qty
50500075ZP	75mm 3"	BZP-E/Galv	10	120
50500100ZP	100mm 4"	BZP-E/Galv	5	60
50500125ZP	125mm 5"	BZP-E/Galv	5	40
50500150ZP	150mm 6"	BZP-E/Galv	5	30
50500075SC	75mm 3"	Self Colour	10	120
50500100SC	100mm 4"	Self Colour	5	60
50500125SC	125mm 5"	Self Colour	5	40
50500150SC	150mm 6"	Self Colour	5	30



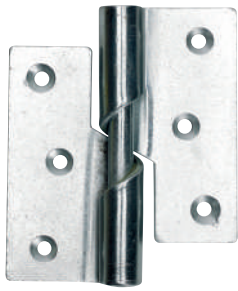

No.466

Rising Butt Hinges

Enables the door to rise slightly when opened.

- Avoids scuffing carpets
- Lubricate frequently in use
- Use a lithium 3 grease

Code	Size	Finish	Box Qty	Ctn Qty
466-0075ZPLH	75mm 3"	BZP-E/Galv	5	40
466-0075ZPRH	75mm 3"	BZP-E/Galv	5	40
466-0100ZPLH	100mm 4"	BZP-E/Galv	5	25
466-0100ZPRH	100mm 4"	BZP-E/Galv	5	25
466-0075SCLH	75mm 3"	Self Colour	5	40
466-0075SCRH	75mm 3"	Self Colour	5	40
466-0100SCLH	100mm 4"	Self Colour	5	25
466-0100SCRH	100mm 4"	Self Colour	5	25



No.488

Parliament Hinge

Cut out to avoid protruding pipework or other obstructions when opening the door beyond 90 degrees.

- Extra wide
- Measurement between legs
- Lubricate frequently in use

Code	Size	Finish	Box Qty	Ctn Qty
488-0075ZP	75mm 3"	BZP-E/Galv	5	50
488-0075SC	75mm 3"	Self Colour	5	50
488-0100SC	100mm 4"	Self Colour	5	25



No.451B

Mild Steel Ball Bearing Butt Hinges

Ball bearing for smooth action.

- Manufactured from Mild Steel
- Retail boxed

Code	Size	Finish	Box Qty	Ctn Qty
451B0075SCP	75mm 3"	Satin Chrome Plated	1	60

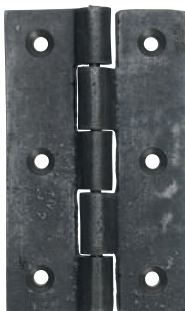

No.200

Cast Iron Butt Hinges

A traditional cast iron hinge.

- Uncranked knuckles
- Fixed riveted pin

Code	Size	Finish	Box Qty	Ctn Qty
200-0063SC	63mm 2½"	Self Colour	10	60
200-0075SC	75mm 3"	Self Colour	10	50
200-0100SC	100mm 4"	Self Colour	5	30



No.467

Stainless Steel Double SS Washered Hinges

Manufactured from Grade 201 Stainless Steel for durability.

- Suitable for use on standard doors
- Corrosion and rust resistant with an uncranked leaf

Code	Size	Finish	Box Qty	Ctn Qty
467-0100SS	100mm 4"	Stainless Steel	5	50

AGRICULTURAL

GATE & SHED

FENCING & LANDSCAPING

DOMESTIC & INTERNAL

ARCHITECTURAL IRONMONGERY

WIRE FORMED PRODUCTS

PACKAGING OPTIONS

BESPOKE LASER CUTTING

No.451

Strong Butt Hinges

A strong general purpose hinge.

- Cranked knuckles
- Fixed riveted pin

Code	Size	Finish	Box Qty	Ctn Qty
451-0075ZP	75mm 3"	BZP-E/Galv	10	60
451-0100ZP	100mm 4"	BZP-E/Galv	5	30
451-0075SC	75mm 3"	Self Colour	10	60
451-0100SC	100mm 4"	Self Colour	5	30

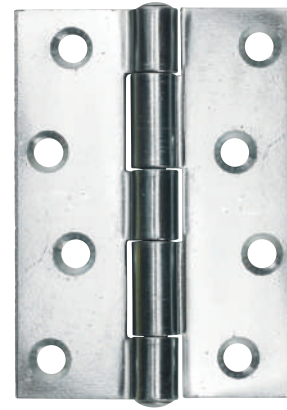

No.451CC

Strong Butt Hinges - Powder Coated

A strong general purpose hinge.

- Cranked knuckles
- Fixed riveted pin
- Colour consistent

Code	Size	Finish	Box Qty	Ctn Qty
451CC0075BK	75mm 3"	Black	5	60
451CC0100BK	100mm 4"	Black	5	30



No.78

Solid Brass Double Steel Washered Butt Hinges

A strong hinge with hardened steel washers and comes with electro brassed steel wood screws.

- Reduced friction
- Polished & lacquered

Code	Size	Finish	Box Qty	Ctn Qty
78-0000PB	76.4 x 50mm	Polished Brass	10	80

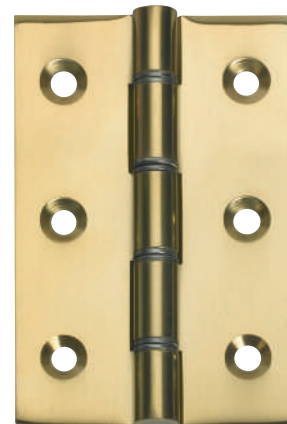

No.899

Double Pressed Butt Hinges

An extra strong hinge ideal for use on frequently used heavy doors.

- Double flapped

Code	Size	Finish	Box Qty	Ctn Qty
899-0100ZP	100mm 4"	BZP-E/Galv	5	30
899-0075SC	75mm 3"	Self Colour	20	50
899-0100SC	100mm 4"	Self Colour	10	30
899-0150SC	150mm 6"	Self Colour	2	10

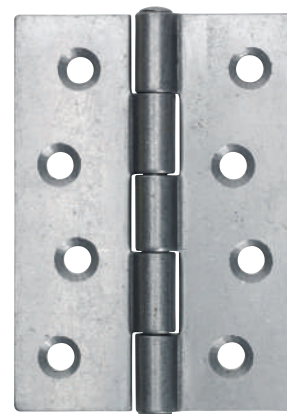

AGRICULTURAL

GATE & SHED

FENCING & LANDSCAPING

DOMESTIC & INTERNAL

ARCHITECTURAL IRONMONGERY

WIRE FORMED PRODUCTS

PACKAGING OPTIONS

BESPOKE LASER CUTTING



No.1838T

Light Narrow Butt Hinges - No Holes

A multi-purpose hinge often welded onto tool boxes etc.

- Pin cannot be removed
- No holes

Code	Size	Finish	Box Qty	Ctn Qty
1838T075SC	75mm 3"	Self Colour	10	120
1838T100SC	100mm 4"	Self Colour	5	60

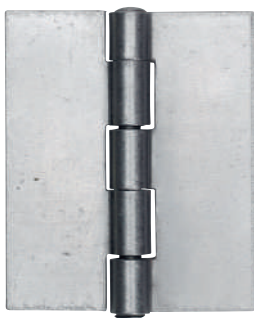

No.451T

Strong Butt Hinges - No Holes

A strong robust hinge for welding onto light metal doors.

- Cranked knuckles
- Fixed riveted pin
- No holes

Code	Size	Finish	Box Qty	Ctn Qty
451T0075SC	75mm 3"	Self Colour	10	60
451T0100SC	100mm 4"	Self Colour	5	30



No.899T

Double Pressed Butt Hinges - No Holes

An extra strong hinge for welding onto steel doors within the security industry.

- Double pressed
- No holes

Code	Size	Finish	Box Qty	Ctn Qty
899T0075SC	75mm 3"	Self Colour	10	50
899T0100SC	100mm 4"	Self Colour	5	30
899T0150SC	150mm 6"	Self Colour	2	10

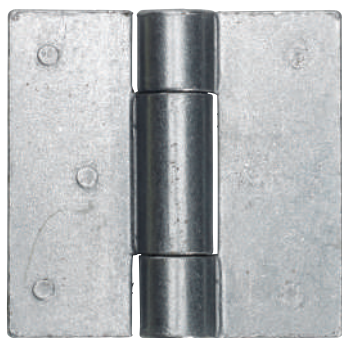

No.575

Welded Butt Hinges

A heavy hinge for welding onto rubbish onto rubbish skips and containers etc.

- Uncranked, double welded plates
- No holes

Code	Size	Finish	Box Qty	Ctn Qty
575-0075SC	75mm 3"	Self Colour	2	20
575-0100SC	100mm 4"	Self Colour	2	12
575-0125SC	125mm 5"	Self Colour	2	8
575-0150SC	150mm 6"	Self Colour	2	10

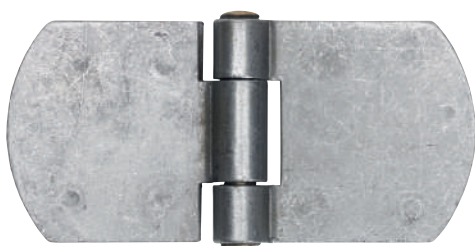

No.579

Heavy Welded Double Flap Backflap Hinges

A heavy hinge for welding within the shipping/maritime industry onto ship doors and hatches.

- Double flapped with brass pin
- No holes

Code	Size	Finish	Box Qty	Ctn Qty
579-50100SC	50 x 100mm	Self Colour	5	30
579-50150SC	50 x 150mm	Self Colour	5	20
579-75200SC	75 x 200mm	Self Colour	-	5

AGRICULTURAL

GATE & SHED

FENCING & LANDSCAPING

DOMESTIC & INTERNAL

ARCHITECTURAL IRONMONGERY

WIRE FORMED PRODUCTS

PACKAGING OPTIONS

BESPOKE LASER CUTTING

No.1951

Stormproof Hinges

For use on casement windows or vent lights.

Code	Size	Finish	Box Qty	Ctn Qty
19510000PECH	63mm	BZP-E/Galv	10	80
19510000YP	63mm	Yellow Passivated	10	80

No.1951/SS

Stainless Steel Stormproof Hinges

Code	Size	Finish	Box Qty	Ctn Qty
19510000PS	63mm	Polished Steel	10	100
19510000SS	63mm	Satin	10	100



No.101

Piano Hinges in 1830mm Lengths

Ideal for piano's or used within the carpentry trade for small chest lids, cabinets & blanket boxes etc.

Code	Size	Finish	Box Qty	Ctn Qty
101-0025EB	25mm	Electro Brass	-	10
101-0032EB	32mm	Electro Brass	-	10
101-0038EB	38mm	Electro Brass	-	10
101-0025NP	25mm	Nickel Plated	-	10
101-0032NP	32mm	Nickel Plated	-	10
101-0038NP	38mm	Nickel Plated	-	10



No.404

Uncranked Backflap Hinges

Ideal for use on furniture such as drop tables or folding shelves etc.

• Riveted steel pin and uncranked knuckle

Code	Size	Finish	Box Qty	Ctn Qty
404-0025ZP	25mm 1"	BZP-E/Galv	25	250
404-0038ZP	38mm 1½"	BZP-E/Galv	10	150
404-0050ZP	50mm 2"	BZP-E/Galv	10	80
404-0038SC	38mm 1½"	Self Colour	10	150
404-0050SC	50mm 2"	Self Colour	10	80

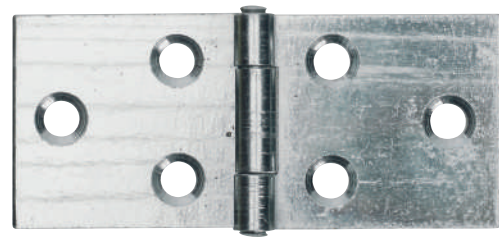

No.400

Cranked Backflap Hinges

Ideal for use on furniture such as drop leaf tables or folding shelves etc.

• Riveted steel pin and cranked knuckle

Code	Size	Finish	Box Qty	Ctn Qty
400-0025ZP	25mm 1"	BZP-E/Galv	25	250
400-0038ZP	38mm 1½"	BZP-E/Galv	10	150
400-0050ZP	50mm 2"	BZP-E/Galv	10	80
400-0063ZP	63mm 2½"	BZP-E/Galv	10	40
400-0025SC	25mm 1"	Self Colour	25	250
400-0050SC	50mm 2"	Self Colour	10	80
400-0063SC	63mm 2½"	Self Colour	10	40



No.1384

Concealed Sprung Hinges

For use within the carpentry trade and ideal for kitchen cabinets or cupboards.

Code	Size	Finish	Box Qty	Ctn Qty
13840000ZP	-	BZP-E/Galv	20	-



No.104

Hurlinges

For use within the carpentry trade and Ideal for wardrobes & cabinets.

- Riveted steel pin

Code	Size	Finish	Box Qty	Ctn Qty
104-0075ZP	75mm 3"	BZP-E/Galv	10	150
104-0100ZP	100mm 4"	BZP-E/Galv	10	80
104-0075CH	75mm 3"	Chrome	10	150
104-0100CH	100mm 4"	Chrome	10	80
104-0100EB	100mm 4"	Electro Brass	10	80
104-0100SC	100mm 4"	Self Colour	10	80

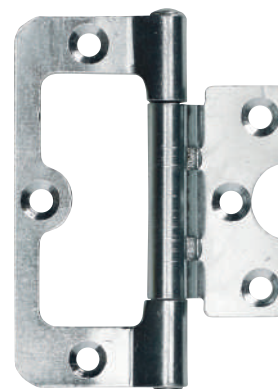

No.104Z

Hurlinges - Loose Pin

For use with light/small doors.

Code	Size	Finish	Box Qty	Ctn Qty
104Z0075ZP	75mm 3"	BZP-E/Galv	10	150
104Z0100ZP	100mm 4"	BZP-E/Galv	10	80
104Z0100CH	100mm 4"	Chrome	10	80

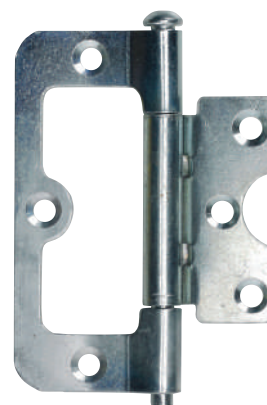

Flush Hinges

For use within the carpentry trade and Ideal for wardrobes & cabinets.

- Totally concealed - except barrel

Code	Size	Finish	Box Qty	Ctn Qty
105-0050ZP	50mm	BZP-E/Galv	25	400
105-0060ZP	60mm	BZP-E/Galv	25	300
105-0075ZP	75mm	BZP-E/Galv	25	150
105-0050EB	50mm	Electro Brass	25	400
105-0060EB	60mm	Electro Brass	25	300
105-0075EB	75mm	Electro Brass	25	150

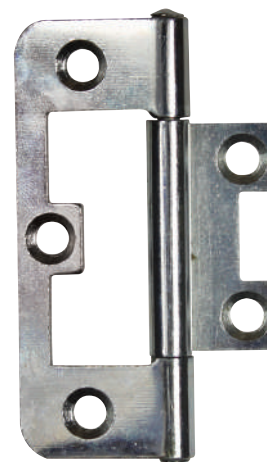

No.105SS

Stainless Steel Ball Bearing Flush Hinges

For use within the carpentry trade and Ideal for wardrobes & cabinets.

- Stainless steel

Code	Size	Finish	Box Qty	Ctn Qty
105-0100PS	100mm 4"	Polished Steel	5	50
105-0100SS	100mm 4"	Satin	5	50

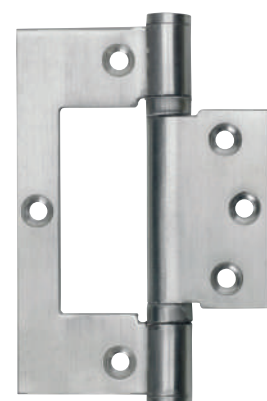

AGRICULTURAL

GATE & SHED

FENCING & LANDSCAPING

DOMESTIC & INTERNAL

ARCHITECTURAL IRONMONGERY

WIRE FORMED PRODUCTS

PACKAGING OPTIONS

BESPOKE LASER CUTTING



O L D H I L L I R O N W O R K S



BLACK ANTIQUE CAST IRON

- Malleable Cast Iron
- Stainless Steel Mechanism
- Premium Decorative Antique Black Finish
- UV Colour Fast Black Powder Coating
- Protective Inner Zinc Coating
- Cast Base Metal
- Salt Spray Tested to Over 700 Hours
- Complete with all Fixings

LEVER HANDLES



MORTICE KNOBS



PULL HANDLES



GATE FURNITURE



FRONT DOOR



TEE HINGES AND HINGE



FRONTS



WINDOW FITTINGS



CABINET HARDWARE



ACCESSORIES



Salt Spray Tested

Our products have been "Salt spray tested" to over 700 hours. Far greater than given to other manufacturers' more expensive products.

Therefore, our Old Hill range has improved durability and life.





Creation

The manufacturing process of our superb range of Old Hill Ironworks hand-finished accessories combines the highest quality malleable cast iron, together with the increased endurance of a stainless steel inner mechanism.

Our malleable cast iron has the best shock resistance and is ductile, with mechanical properties of elasticity and impact strength, making it the ideal material for use in this high quality range.

The powder coating process creates a premium decorative antique black finish which will give your products an extended life.



AGRICULTURAL

GATE & SHED

FENCING & LANDSCAPING

DOMESTIC & INTERNAL

ARCHITECTURAL IRONMONGERY

WIRE FORMED PRODUCTS

PACKAGING OPTIONS

BESPOKE LASER CUTTING

Old Hill Ironworks Product Features & Finishes



Salt Spray Tested

Our products have been "**Salt spray tested**" to over 700 hours. Far greater than given to other manufacturers' more expensive products. Therefore, our Old Hill range has improved durability and life.

Flat and raised head screws are black passivated stainless steel, providing corrosion resistance and durability.

Fixings



Mechanism

Stainless steel mechanism, washers and cams offer increased durability and endurance, allowing for a softer and more progressive lever operation.

UV colour fast black powder coat reduces the likelihood of fading and better resists oxidation.

All coatings are from recognised global brands no recycled material is used.

Outer Coating

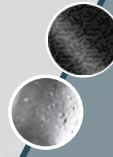

Inner Coating

A **protective zinc rich powder coat finish** is applied under the decorative finish to provide further durability.



Cast base metal

Extremely durable high quality **Malleable Iron** base metal shot blasted before protective coating are applied.



AGRICULTURAL

GATE & SHED

FENCING & LANDSCAPING

DOMESTIC & INTERNAL

ARCHITECTURAL IRONMONGERY

WIRE FORMED PRODUCTS

PACKAGING OPTIONS

BESPOKE LASER CUTTING

AGRICULTURAL
GATE & SHED
FENCING & LANDSCAPING
DOMESTIC & INTERNAL
ARCHITECTURAL IRONMONGERY
WIRE FORMED PRODUCTS
PACKAGING OPTIONS
BESPOKE LASER CUTTING



4005



4006



4007



4008

No.4005

Charlbury Suite Lever Latch Handles

Code	Size	Finish	Box Qty	Ctn Qty
4005-0000BA	158mm x 38mm	Black Antique	1	10

No.4006

Charlbury Suite Lever Lock Handles

Code	Size	Finish	Box Qty	Ctn Qty
4006-0000BA	158mm x 38mm	Black Antique	1	10

No.4007

Charlbury Suite Lever Euro Cylinder Handles

Code	Size	Finish	Box Qty	Ctn Qty
4007-0000BA	158mm x 38mm	Black Antique	1	10

No.4008

Charlbury Suite Lever Bathroom Handles

Code	Size	Finish	Box Qty	Ctn Qty
4008-0000BA	158mm x 38mm	Black Antique	1	10



4015



4016



4018

No.4015

Wychwood Suite Lever Latch Handles

Code	Size	Finish	Box Qty	Ctn Qty
4015-0000BA	165mm x 52mm	Black Antique	1	10

No.4016

Wychwood Suite Lever Lock Handles

Code	Size	Finish	Box Qty	Ctn Qty
4016-0000BA	165mm x 52mm	Black Antique	1	10

No.4018

Wychwood Suite Lever Bathroom Handles

Code	Size	Finish	Box Qty	Ctn Qty
4018-0000BA	165mm x 52mm	Black Antique	1	10



4020



4021



4023

No.4020

Laverton Suite Lever Latch Handles

Code	Size	Finish	Box Qty	Ctn Qty
4020-0000BA	172mm x 48mm	Black Antique	1	10

No.4021

Laverton Suite Lever Lock Handles

Code	Size	Finish	Box Qty	Ctn Qty
4021-0000BA	172mm x 48mm	Black Antique	1	10

No.4023

Laverton Suite Lever Bathroom Handles

Code	Size	Finish	Box Qty	Ctn Qty
4023-0000BA	172mm x 48mm	Black Antique	1	10



Old Hill Ironworks Traditional Door Furniture

No.4000

Burford Suite Lever Latch Handles

Code	Size	Finish	Box Qty	Ctn Qty
4000-0000BA	158mm x 55mm	Black Antique	1	10

No.4001

Burford Suite Lever Lock Handles

Code	Size	Finish	Box Qty	Ctn Qty
4001-0000BA	158mm x 55mm	Black Antique	1	10

No.4002

Burford Suite Lever Euro Cylinder Handles

Code	Size	Finish	Box Qty	Ctn Qty
4002-0000BA	158mm x 55mm	Black Antique	1	10

No.4003

Burford Suite Lever Bathroom Handles

Code	Size	Finish	Box Qty	Ctn Qty
4003-0000BA	158mm x 55mm	Black Antique	1	10

No.4010

Fulbrook Suite Lever Latch Handles

Code	Size	Finish	Box Qty	Ctn Qty
4010-0000BA	210mm x 57mm	Black Antique	1	10

No.4011

Fulbrook Suite Lever Lock Handles

Code	Size	Finish	Box Qty	Ctn Qty
4011-0000BA	210mm x 57mm	Black Antique	1	10

No.4013

Fulbrook Suite Lever Bathroom Handles

Code	Size	Finish	Box Qty	Ctn Qty
4013-0000BA	210mm x 57mm	Black Antique	1	10

No.4027

Barley Twist Narrow Plate Suite Lever Euro Cylinder Handles

Code	Size	Finish	Box Qty	Ctn Qty
4027-0000BA	220mm x 30mm	Black Antique	1	10



4001



4002



4003



4000



4011



4013



4010



4027

AGRICULTURAL

GATE & SHED

FENCING & LANDSCAPING

DOMESTIC & INTERNAL

ARCHITECTURAL IRONMONGERY

WIRE FORMED PRODUCTS

PACKAGING OPTIONS

BESPOKE LASER CUTTING

AGRICULTURAL

GATE & SHED

FENCING & LANDSCAPING

DOMESTIC & INTERNAL

ARCHITECTURAL IRONMONGERY

WIRE FORMED PRODUCTS

PACKAGING OPTIONS

BESPOKE LASER CUTTING



No.4300

Ball Mortice Knob Sets (Sprung)

Code	Size	Finish	Box Qty	Ctn Qty
4300-0045BA	45mm	Black Antique	1	10



No.4301

Ball Mortice Rim Knob Sets (Unsprung)

Code	Size	Finish	Box Qty	Ctn Qty
4301-0045BA	45mm	Black Antique	1	10



Oval Open Escutcheon
51mm x 34mm



No.4302

Oval Mortice Knob Sets (Sprung)

Code	Size	Finish	Box Qty	Ctn Qty
4302-0060BA	60mm	Black Antique	1	10



No.4303

Oval Mortice Rim Knob Sets (Unsprung)

Code	Size	Finish	Box Qty	Ctn Qty
4303-0060BA	60mm	Black Antique	1	10



Oval Open Escutcheon
51mm x 34mm



No.4304

Octagonal Mortice Knob Sets (Unsprung)

Code	Size	Finish	Box Qty	Ctn Qty
4304-0056BA	56mm	Black Antique	1	10



Oval Open Escutcheon
51mm x 34mm

Old Hill Ironworks Traditional Door Furniture

No.4355

Oval Open Escutcheon

Code	Size	Finish	Box Qty	Ctn Qty
4355-0034BA	34mm x 51mm	Black Antique	20	200



No.4358

Round Covered Escutcheon

Code	Size	Finish	Box Qty	Ctn Qty
4358-0040BA	40mm	Black Antique	20	200



No.4360

Plaque Covered Escutcheon

Code	Size	Finish	Box Qty	Ctn Qty
4360-0046BA	46mm x 30mm	Black Antique	20	120



No.4353

Floral Escutcheon

Code	Size	Finish	Box Qty	Ctn Qty
4353-0047BA	47mm x 32mm	Black Antique	20	120



No.4351

Fleur de Lys Escutcheon

Code	Size	Finish	Box Qty	Ctn Qty
4351-0084BA	84mm x 30mm	Black Antique	20	120



AGRICULTURAL

GATE & SHED

FENCING & LANDSCAPING

DOMESTIC & INTERNAL

ARCHITECTURAL IRONMONGERY

WIRE FORMED PRODUCTS

PACKAGING OPTIONS

BESPOKE LASER CUTTING



No.4350

Oval Thumb Turn and Release

Code	Size	Finish	Box Qty	Ctn Qty
4350-0038BA	38mm	Black Antique	4	24



POWDER COATING

Outer Coating

UV colour fast black powder coat reduces the likelihood of fading and better resists oxidation. All coatings are from recognised global brands no recycled material is used.

Inner Coating

A protective zinc rich **powder coat finish** is applied under the decorative finish to provide further durability.



No.4252

Fleur de Lys Cranked Pull Handle

Code	Size	Finish	Box Qty	Ctn Qty
4252-0000BARH	265mm x 45mm	Black Antique	1	10
4252-0000BALH	265mm x 45mm	Black Antique	1	10



No.4254

Pub Style Pull Handle

Code	Size	Finish	Box Qty	Ctn Qty
4254-0000BA	245mm	Black Antique	1	20



AGRICULTURAL

GATE & SHED

FENCING & LANDSCAPING

DOMESTIC & INTERNAL

ARCHITECTURAL IRONMONGERY

WIRE FORMED PRODUCTS

PACKAGING OPTIONS

BESPOKE LASER CUTTING

No.4251



Fleur de Lys Pull Handle

Code	Size	Finish	Box Qty	Ctn Qty
4251-0130BA	130mm	Black Antique	4	40
4251-0175BA	175mm	Black Antique	4	40



No.4250



Cranked Pull Handle on Rose

Code	Size	Finish	Box Qty	Ctn Qty
4250-0240BA	240mm	Black Antique	1	10



No.4253



Rectangular Finger Plate

Code	Size	Finish	Box Qty	Ctn Qty
4253-0315BA	315mm x 68mm	Black Antique	2	20



UKANDIN IN HOUSE MANUFACTURING CAPABILITY

Pressed Steel & Aluminium • Forged Steel & Brass
 Casting • Thread Rolling • Wire Forming
 Injection Moulding • Finishing • Laser Cutting



AGRICULTURAL

GATE & SHED

FENCING & LANDSCAPING

DOMESTIC & INTERNAL

ARCHITECTURAL IRONMONGERY

WIRE FORMED PRODUCTS

PACKAGING OPTIONS

BESPOKE LASER CUTTING



No.4416

Fleur de Lys Twisted Ring Latch (Heavy Duty)



Code	Size	Finish	Box Qty	Ctn Qty
4416-0210BA	210mm 8"	Black Antique	1	10



No.4414

Cottage Style Ring Gate Latch



Code	Size	Finish	Box Qty	Ctn Qty
4414-0152BA	152mm 6"	Black Antique	1	10



No.4401

Fleur de Lys Thumb Latch Set



Code	Size	Finish	Box Qty	Ctn Qty
4401-0203BA	203mm	Black Antique	1	10



No.4404

Cottage Thumb Latch Set



Code	Size	Finish	Box Qty	Ctn Qty
4404-0200BA	200mm	Black Antique	1	10



No.4402

Lakeland Thumb Latch Set



Code	Size	Finish	Box Qty	Ctn Qty
4402-0185BA	185mm x 40mm	Black Antique	1	10

No.4374

Blacksmiths Straight Door Bolt

Code	Size	Finish	Box Qty	Ctn Qty
4374-0102BA	102mm	Black Antique	6	60
4374-0155BA	155mm	Black Antique	4	40
4374-0204BA	204mm	Black Antique	2	20



No.4375

Cabin Hook

Code	Size	Finish	Box Qty	Ctn Qty
4375-0102BA	102mm 4"	Black Antique	5	20
4375-0150BA	152mm 6"	Black Antique	5	50
4375-0203BA	203mm 8"	Black Antique	5	50
4375-0305BA	305mm 12"	Black Antique	4	16



No.4200

Tudor Tee Hinge

Code	Size	Finish	Box Qty	Ctn Qty
4200-0229BA	229mm 9"	Black Antique	1	20
4200-0305BA	305mm 12"	Black Antique	1	20
4200-0390BA	390mm 15"	Black Antique	1	10
4200-0465BA	465mm 18"	Black Antique	1	10



No.4201

Tudor Hinge Front

Code	Size	Finish	Box Qty	Ctn Qty
4201-0229BA	229mm 9"	Black Antique	1	20
4201-0305BA	305mm 12"	Black Antique	1	20
4201-0390BA	390mm 15"	Black Antique	1	10
4201-0465BA	465mm 18"	Black Antique	1	10



No.4202

Fleur de Lys Tee Hinges

Code	Size	Finish	Box Qty	Ctn Qty
4202-0460BA	460mm 18"	Black Antique	1	10



No.4203

Fleur de Lys Hinge Front

Code	Size	Finish	Box Qty	Ctn Qty
4203-0470BA	470mm 18½"	Black Antique	1	10



AGRICULTURAL

GATE & SHED

FENCING & LANDSCAPING

DOMESTIC & INTERNAL

ARCHITECTURAL IRONMONGERY

WIRE FORMED PRODUCTS

PACKAGING OPTIONS

BESPOKE LASER CUTTING

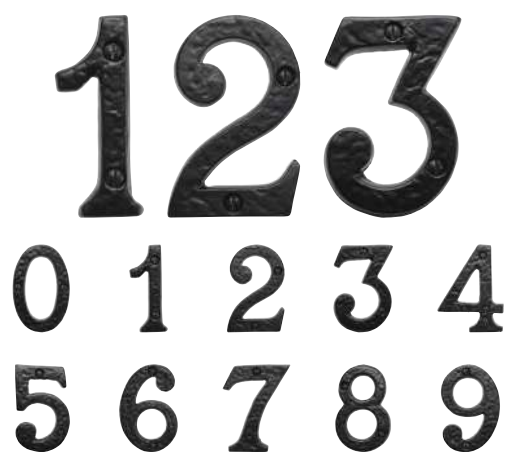

No.4366

Numerals (0 - 9)

Code	Size	Finish	Box Qty	Ctn Qty
4366-0076BA	76mm	Black Antique	15	150
4366-1076BA	76mm	Black Antique	15	150
4366-2076BA	76mm	Black Antique	15	150
4366-3076BA	76mm	Black Antique	15	150
4366-4076BA	76mm	Black Antique	15	150
4366-5076BA	76mm	Black Antique	15	150
4366-6076BA	76mm	Black Antique	15	150
4366-7076BA	76mm	Black Antique	15	150
4366-8076BA	76mm	Black Antique	15	150
4366-9076BA	76mm	Black Antique	15	150



No.4361

Door Studs

Code	Size	Finish	Box Qty	Ctn Qty
4361-0015BA	15mm	Black Antique	25	250
4361-0023BA	23mm	Black Antique	20	200



No.4370

Octagonal Centre Door Knob

Code	Size	Finish	Box Qty	Ctn Qty
4370-0063BA	63mm	Black Antique	1	10



No.4365

Fleur de Lys Door Chain

Code	Size	Finish	Box Qty	Ctn Qty
4365-0135BA	135mm x 85mm	Black Antique	5	50



CAST BASE METAL

The **cast base metal** of the Old Hill Ironworks range is extremely durable high quality **Malleable Iron** base which is metal shot blasted before protective coating are applied to prolong life.



AGRICULTURAL
GATE & SHED
FENCING & LANDSCAPING
DOMESTIC & INTERNAL
ARCHITECTURAL IRONMONGERY
WIRE FORMED PRODUCTS
PACKAGING OPTIONS
BESPOKE LASER CUTTING

No.4364

Fleur de Lys Cylinder Pull



Code	Size	Finish	Box Qty	Ctn Qty
4364-0144BA	144mm x 63mm	Black Antique	5	50



No.4362

Rectangular Bell Push



Code	Size	Finish	Box Qty	Ctn Qty
4362-0080BA	80mm x 45mm	Black Antique	6	120



No.4363

Fleur de Lys Bell Push



Code	Size	Finish	Box Qty	Ctn Qty
4363-0120BA	120mm x 30mm	Black Antique	6	120



No.4371

Traditional Rectangular Letter Plate



Code	Size	Finish	Box Qty	Ctn Qty
4371-0260BA	260mm x 90mm	Black Antique	1	10

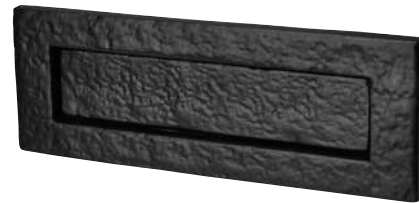

No.4372

Fleur de Lys Letter Plate



Code	Size	Finish	Box Qty	Ctn Qty
4372-0370BA	370mm x 95mm	Black Antique	1	20

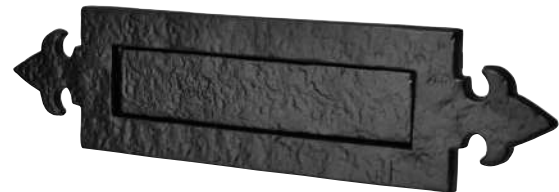

No.4373

Rectangular Inner Letter Plate Tidy



Code	Size	Finish	Box Qty	Ctn Qty
4373-0295BA	295mm x 80mm	Black Antique	1	10



AGRICULTURAL

GATE & SHED

FENCING & LANDSCAPING

DOMESTIC & INTERNAL

ARCHITECTURAL IRONMONGERY

WIRE FORMED PRODUCTS

PACKAGING OPTIONS

BESPOKE LASER CUTTING



No.4367

Lion Head Door Knocker

Code	Size	Finish	Box Qty	Ctn Qty
4367-0090BA	90mm	Black Antique	1	10



No.4368

Fleur de Lys Ring Door Knocker

Code	Size	Finish	Box Qty	Ctn Qty
4368-0095BA	95mm	Black Antique	1	10



No.4369

Fleur de Lys Slimline Door Knocker

Code	Size	Finish	Box Qty	Ctn Qty
4369-0070BA	70mm	Black Antique	1	10



No.4460

Victorian Hat and Coat Hook

Code	Size	Finish	Box Qty	Ctn Qty
4460-0135BA	135mm	Black Antique	6	60



No.4461

Heavy Scroll Hat and Coat Hook

Code	Size	Finish	Box Qty	Ctn Qty
4461-0000BA	135mm	Black Antique	12	48



AGRICULTURAL

GATE & SHED

FENCING & LANDSCAPING

DOMESTIC & INTERNAL

ARCHITECTURAL IRONMONGERY

WIRE FORMED PRODUCTS

PACKAGING OPTIONS

BESPOKE LASER CUTTING

Old Hill Ironworks Traditional Door Furniture

No.4462



Heavy Hat and Coat Hook

Code	Size	Finish	Box Qty	Ctn Qty
4462-0135BA	135mm	Black Antique	5	50



No.4463



Barely Twist Hat and Coat Hook

Code	Size	Finish	Box Qty	Ctn Qty
4463-0145BA	145mm	Black Antique	6	60



No.4376



Projection Skirting Mounted Doorstop

Code	Size	Finish	Box Qty	Ctn Qty
4376-0076BA	76mm	Black Antique	10	60



No.4453



Barely Twist Single Robe Hook

Code	Size	Finish	Box Qty	Ctn Qty
4453-0055BA	55mm	Black Antique	6	60



No.4472



Heavy Pattern Handrail Bracket

Code	Size	Finish	Box Qty	Ctn Qty
4472-0064BA	64mm	Black Antique	4	40



No.4474



Cottage Handrail Bracket

Code	Size	Finish	Box Qty	Ctn Qty
4474-0064BA	64mm	Black Antique	5	50
4474-0076BA	76mm	Black Antique	5	50



AGRICULTURAL

GATE & SHED

FENCING & LANDSCAPING

DOMESTIC & INTERNAL

ARCHITECTURAL IRONMONGERY

WIRE FORMED PRODUCTS

PACKAGING OPTIONS

BESPOKE LASER CUTTING



No.4600

Curly Tail Reversible Casement Fastener

Code	Size	Finish	Box Qty	Ctn Qty
4600-0000BA	58mm x 24mm	Black Antique	5	30



No.4601

Curly Tail Locking Wedge Fastener Left and Right Hand (Left Hand Shown)

Code	Size	Finish	Box Qty	Ctn Qty
4601-0057BALH	57mm	Black Antique	6	36
4601-0057BARH	57mm	Black Antique	6	36



No.4602

Curly Tail Locking Espagnolette Fastener Left and Right Hand (Left Hand Shown)

Code	Size	Finish	Box Qty	Ctn Qty
4602-0000BALH	57mm	Black Antique	5	30
4602-0000BARH	57mm	Black Antique	5	30



No.4603

Curly Tail Slim Locking Espagnolette Fastener Left and Right Hand (Right Hand Shown)

Code	Size	Finish	Box Qty	Ctn Qty
4603-0058BALH	58mm	Black Antique	6	60
4603-0058BARH	58mm	Black Antique	6	60



No.4612

Bulb End Locking Espagnolette Fastener Left and Right Hand (Right Hand Shown)

Code	Size	Finish	Box Qty	Ctn Qty
4612-0000BALH	58mm	Black Antique	5	30
4612-0000BARH	58mm	Black Antique	5	30



AGRICULTURAL

GATE & SHED

FENCING & LANDSCAPING

DOMESTIC & INTERNAL

ARCHITECTURAL IRONMONGERY

WIRE FORMED PRODUCTS

PACKAGING OPTIONS

BESPOKE LASER CUTTING

No.4610

**Bulb End Reversible Casement Fastener**

Code	Size	Finish	Box Qty	Ctn Qty
4610-0058BA	58mm x 24mm	Black Antique	6	36



No.4614

**Bulb End Casement Stays**

Code	Size	Finish	Box Qty	Ctn Qty
4614-0203BA	203mm 8"	Black Antique	12	48
4614-0254BA	254mm 10"	Black Antique	5	20
4614-0305BA	305mm 12"	Black Antique	8	32



No.4604

**Curly Tail Casement Stay**

Code	Size	Finish	Box Qty	Ctn Qty
4604-0203BA	203mm 8"	Black Antique	12	48
4604-0254BA	254mm 10"	Black Antique	5	20
4604-0305BA	305mm 12"	Black Antique	8	32



No.4620

**Sash Window Fitch Fastener**

Code	Size	Finish	Box Qty	Ctn Qty
4620-0072BA	72mm x 36mm	Black Antique	5	50



No.4621

**Sash Window Finger Pull**

Code	Size	Finish	Box Qty	Ctn Qty
4621-0063BA	63mm x 37mm	Black Antique	10	60



No.4622

**Sash Window Ring Pull**

Code	Size	Finish	Box Qty	Ctn Qty
4622-0082BA	82mm x 38mm	Black Antique	10	60



AGRICULTURAL

GATE & SHED

FENCING & LANDSCAPING

DOMESTIC & INTERNAL

ARCHITECTURAL IRONMONGERY

WIRE FORMED PRODUCTS

PACKAGING OPTIONS

BESPOKE LASER CUTTING

AGRICULTURAL



No.4522

Hammered Pattern Ball Knob

Code	Size	Finish	Box Qty	Ctn Qty
4522-0028BA	28mm	Black Antique	12	48
4522-0032BA	32mm	Black Antique	12	48



GATE & SHED



No.4524

Hammered Pattern Oval Knob

Code	Size	Finish	Box Qty	Ctn Qty
4524-0038BA	38mm	Black Antique	12	48



FENCING & LANDSCAPING



No.4527

Oval Knob on Round Rose

Code	Size	Finish	Box Qty	Ctn Qty
4527-0036BA	36mm	Black Antique	12	48



DOMESTIC & INTERNAL



No.4560

Tee Handle Cupboard Latch

Code	Size	Finish	Box Qty	Ctn Qty
4560-0075BA	75mm	Black Antique	4	40



WIRE FORMED PRODUCTS



No.4501

Heavy Decorative Cabinet Hinge

Code	Size	Finish	Box Qty	Ctn Qty
4501-0135BA	135mm x 110mm	Black Antique	4	24



PACKAGING OPTIONS

BESPOKE LASER CUTTING

Old Hill Ironworks Traditional Door Furniture

No.4540

Ring Pull on Gothic Back Plate



Code	Size	Finish	Box Qty	Ctn Qty
4540-0058BA	58mm	Black Antique	18	180

No.4500

Cabinet Snake Hinge



Code	Size	Finish	Box Qty	Ctn Qty
4500-0070BA	70mm x 45mm	Black Antique	16	160

OUTER COATING

UV colour fast black powder coat reduces the likelihood of fading and better resists oxidation. All coatings are from recognised global brands no recycled material is used.



AGRICULTURAL

GATE & SHED

FENCING & LANDSCAPING

DOMESTIC & INTERNAL

ARCHITECTURAL IRONMONGERY

WIRE FORMED PRODUCTS

PACKAGING OPTIONS

BESPOKE LASER CUTTING

A collection of designs in a classic and authentic black antique style. The Forge is a quality range of blacksmith style ironmongery, offered as an alternative to the exceptionally high quality Old Hill Ironworks range.



No.723

Antique Lever Lock Handles

Antique design.

- Traditional black finish
- Is supplied as a set with all fittings and compatible with all mortice latches

Code	Size	Finish	Box Qty	Ctn Qty
723-0000BK	150mm 6"	Black	-	10



No.724

Fleur-de-Lys Lever Lock Handles

Antique design.

- Hammered texture finish

Code	Size	Finish	Box Qty	Ctn Qty
724-0000BK	200mm 8"	Black	-	10



No.75

Offset Handle

Extremely versatile and hard wearing handle.

- For use on doors, gates and cabinets

Code	Size	Finish	Box Qty	Ctn Qty
75-0150BK	150mm 6"	Black	10	80
75-0150GV	150mm 6"	Galv'd	10	80

AGRICULTURAL

GATE & SHED

FENCING & LANDSCAPING

DOMESTIC & INTERNAL

ARCHITECTURAL IRONMONGERY

WIRE FORMED PRODUCTS

PACKAGING OPTIONS

BESPOKE LASER CUTTING

No.1928

Tubular Steel Handles

Extremely versatile and hard wearing handle.

- For use on doors, gates and cabinets

Code	Size	Finish	Box Qty	Ctn Qty
19280150BK	150mm 6"	Black	25	200
19280180BK	180mm 7"	Black	25	200
19280150ZP	150mm 6"	BZP-E/Galv	25	200
19280180ZP	180mm 7"	BZP-E/Galv	25	200



No.891

Hot Bed Handles

Extremely versatile and hard wearing handle.

- For use on doors, gates and cabinets

Code	Size	Finish	Box Qty	Ctn Qty
891-0150BK	150mm 6"	Black	25	125
891-0180BK	180mm 7"	Black	25	125
891-0150GV	150mm 6"	Galv'd	25	125
891-0180GV	180mm 7"	Galv'd	25	125



No.707

Unequal Hinges

For use within the carpentry trade. Ideal for cabinets, sheds and summerhouses.

- Antique black finish
- Complete with screws

Code	Size	Finish	Box Qty	Ctn Qty
707-0000BK	110mm x 80mm	Black	10	60



AGRICULTURAL

GATE & SHED

FENCING & LANDSCAPING

DOMESTIC & INTERNAL

ARCHITECTURAL IRONMONGERY

WIRE FORMED PRODUCTS

PACKAGING OPTIONS

BESPOKE LASER CUTTING



No.271

Cast Oval Knob Sets (Rim & Mortice)

Code	Size	Finish	Box Qty	Ctn Qty
271-000BK	55mm	Black	5	20



No.272

Cast Ball Knob Sets (Rim & Mortice)

Code	Size	Finish	Box Qty	Ctn Qty
272-000BK	55mm	Black	5	20



No.273

Cast Octagonal Knob Sets (Rim & Mortice)

Code	Size	Finish	Box Qty	Ctn Qty
273-000BK	60mm	Black	5	20

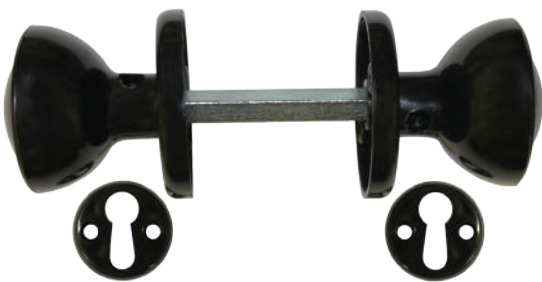

No.270

Plastic Mortice Knob Set

An economy Mortice Knob door manufactured from plastic.

- To suit Rim and Mortice Locks.

Code	Size	Finish	Box Qty	Ctn Qty
270-000BK	53mm	Black	10	50



CERTIFIED QUALITY



AGRICULTURAL
GATE & SHED
FENCING & LANDSCAPING
DOMESTIC & INTERNAL
ARCHITECTURAL IRONMONGERY
WIRE FORMED PRODUCTS
PACKAGING OPTIONS
BESPOKE LASER CUTTING



WIRE FORMED PRODUCTS

Engineered U Bolts

108 Engineered Fasteners

109

AGRICULTURAL
 GATE & SHED
 FENCING & LANDSCAPING
 DOMESTIC & INTERNAL
 ARCHITECTURAL IRONMONGERY
 WIRE FORMED PRODUCTS
 PACKAGING OPTIONS
 BESPOKE LASER CUTTING

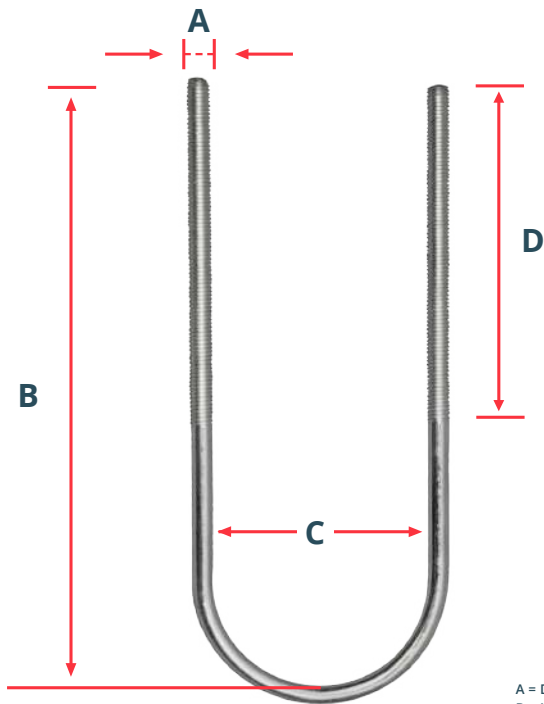

A = Diameter
 B = Inside Length
 C = Inside Width
 D = Thread Length

No.6202

Engineered Grade 4.8 U Bolts - Extended Leg

• Manufactured to order

Code	A	B	C	D
6203M-08090-060040ZP	M10 x 25NB	111mm	34mm	70mm
6203M-10064-034032ZP	M10 x 32NB	122mm	42mm	90mm
6203M-10070-042040ZP	M10 x 40NB	127mm	50mm	90mm
6203M-10080-050040ZP	M10 x 50NB	140mm	60mm	90mm
6203M-10090-060040ZP	M10 x 65NB	150mm	76mm	90mm
6203M-10105-076040ZP	M10 x 80NB	168mm	90mm	90mm
6203M-10116-090040ZP	M10 x 100NB	191mm	114mm	90mm
6203M-10140-114040ZP	M10 x 150NB	240mm	170mm	90mm
6203M-10168-140040ZP	M12 x 80NB	168mm	90mm	90mm
6203M-12116-090040ZP	M12 x 100NB	193mm	114mm	90mm
6203M-12140-114040ZP	M12 x 125NB	213mm	140mm	90mm
6203M-12170-140040ZP	M12 x 150NB	240mm	170mm	90mm
6203M-12202-170040ZP	M12 x 200NB	298mm	220mm	95mm
6203M-12270-220060ZP	M12 x 250NB	347mm	276mm	100mm
6203M-16270-220060ZP	M16 x 200NB	298mm	220mm	95mm

No.6203

Engineered Grade 4.8 U Bolts - Standard Leg

• Manufactured to order

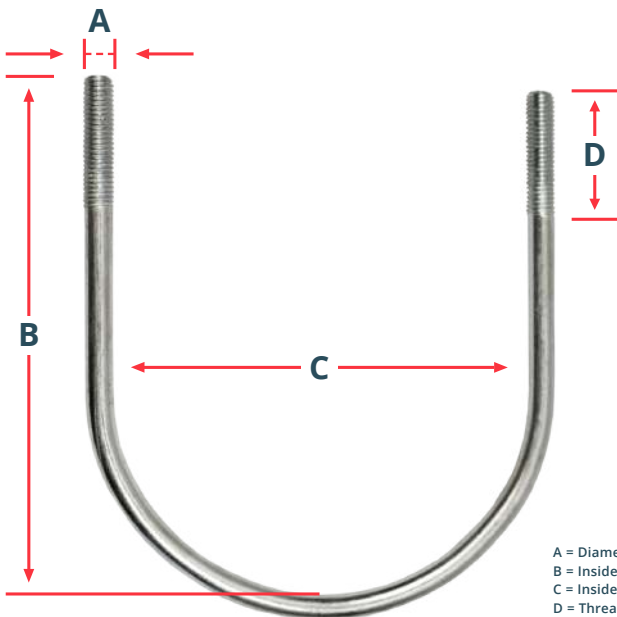

A = Diameter
 B = Inside Length
 C = Inside Width
 D = Thread Length

Code	A	B	C	D
6203M-06048-021030ZP	M6 x 15NB	48mm	21mm	30mm
6203M-06053-027030ZP	M6 x 20NB	53mm	27mm	30mm
6203M-06060-034030ZP	M6 x 25NB	60mm	34mm	30mm
6203M-08064-034030ZP	M8 x 25NB	64mm	34mm	30mm
6203M-08070-042040ZP	M8 x 32NB	70mm	42mm	40mm
6203M-08090-060040ZP	M8 x 50NB	90mm	60mm	40mm
6203M-10064-034032ZP	M10 x 25NB	64mm	34mm	32mm
6203M-10070-042040ZP	M10 x 32NB	70mm	42mm	40mm
6203M-10080-050040ZP	M10 x 40NB	80mm	50mm	40mm
6203M-10090-060040ZP	M10 x 50NB	90mm	60mm	40mm
6203M-10105-076040ZP	M10 x 65NB	105mm	76mm	40mm
6203M-10116-090040ZP	M10 x 80NB	116mm	90mm	40mm
6203M-10140-114040ZP	M10 x 100NB	140mm	114mm	40mm
6203M-10168-140040ZP	M10 x 125NB	168mm	140mm	40mm
6203M-12116-090040ZP	M12 x 80NB	116mm	90mm	40mm
6203M-12140-114040ZP	M12 x 100NB	140mm	114mm	40mm
6203M-12170-140040ZP	M12 x 125NB	170mm	140mm	40mm
6203M-12202-170040ZP	M12 x 150NB	202mm	170mm	40mm
6203M-12270-220060ZP	M12 x 200NB	270mm	220mm	60mm
6203M-16270-220060ZP	M16 x 200NB	270mm	220mm	60mm

No.6207

Square U Bolt

Square 'U' or 'C' Bolts are used for clamping square or rectangular items.

- Available in all sizes
- Manufactured to order

A - Diameter	B - Inside Length	C - Inside Width	D - Thread Length
M6	To your requirements		
M8	To your requirements		
M10	To your requirements		
M12	To your requirements		
M16	To your requirements		

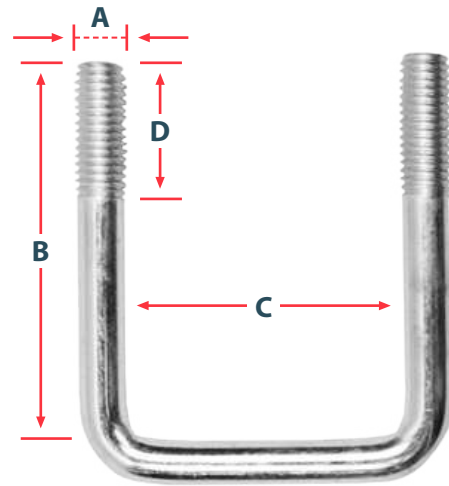

A = Diameter
B = Inside Length
C = Inside Width
D = Thread Length

No.6208

V Bolt / Aerial Bolt

V Bolts / Aerial Bolts can be used for multiple applications, most usually for clamping aerial poles and masts to brackets.

- Available in all sizes
- Manufactured to order

A - Diameter	B - Inside Length	C - Inside Width	D - Thread Length
M6	To your requirements		
M8	To your requirements		
M10	To your requirements		
M12	To your requirements		
M16	To your requirements		

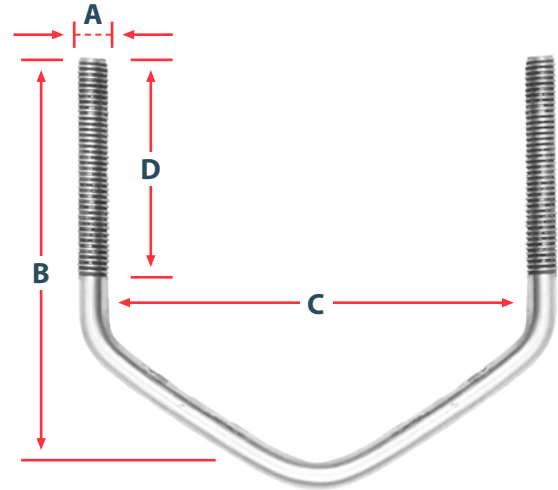

A = Diameter
B = Inside Length
C = Inside Width
D = Thread Length

No.6214

Folded Eye Bolts

Threaded Folded Eyebolts, commonly used for steel cable and for wire fencing support.

- Multiple finishes
- Unwelded eye
- Fully threaded

A - Diameter	B - Length Centre Eye	C - Eye Diameter	D - Thread Length
M6	To your requirements		
M8	To your requirements		
M10	To your requirements		
M12	To your requirements		
M16	To your requirements		

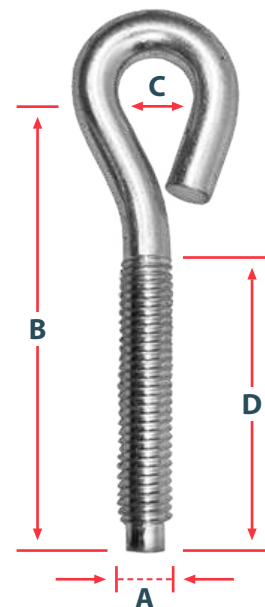

A = Diameter
B = Length Centre Eye
C = Eye Diameter
D = Thread Length

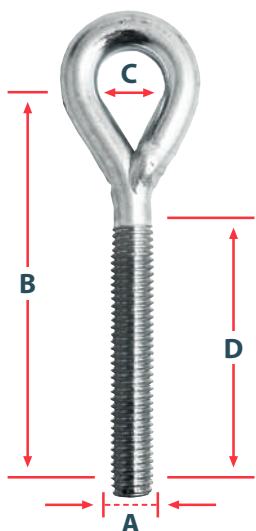

A = Diameter
B = Length Centre Eye
C = Eye Diameter
D = Thread Length

No.6221

Welded Eye Bolts

An industrial/commercial grade eyebolt ideal for light duty non-lifting applications.

- Multiple finishes
- Welded eye
- Steel
- Not load tested for lifting
- Fully threaded

A - Diameter	B - Length Centre Eye	C - Eye Diameter	D - Thread Length
M6		To your requirements	
M8		To your requirements	
M10		To your requirements	
M12		To your requirements	
M16		To your requirements	

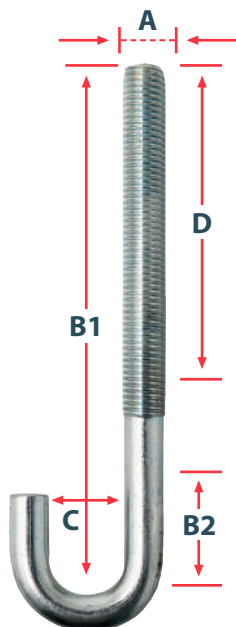

A = Diameter
B1 = Inside Length 1
B2 = Inside Length 2
C = Inside Width
D = Thread Length

No.6204

J Bolts

J Bolts are J shaped fasteners, threaded on the flat side. Often used in structural applications for structural components.

As a leading J Bolt manufacturer, A. Perry can manufacture speciality J Bolts to virtually any specification.

A - Diameter	B - Inside Length	C - Inside Width	D - Thread Length
M6		To your requirements	
M8		To your requirements	
M10		To your requirements	
M12		To your requirements	
M16		To your requirements	

MANUFACTURED TO ORDER

Whether you have a technical drawing or you know the specifications you need, Ukandin can produce to your exact requirements, Simply tell us your requirement and we will remove the stress and hassle, delivering a high quality product to you.

Across the company Ukandin are proactive in our approach to you.

Our aim is to benefit you by delivering high quality products, on time, in budget, in specification - first time and every time.

We know our success depends on your success.



ENVIRONMENTALLY RESPONSIBLE
PACKAGING



95% of Plastic Removed

50% Total waste Reduction

All Packaging **100%** Recyclable Material

Enhanced Product Visibility



New Eco-Packaging can fit up to **Double** the stock compared to plastic packaging

FOR MORE INFORMATION VISIT US ONLINE: WWW.UKANDIN.COM

BESPOKE LASER CUTTING

AGRICULTURAL

GATE & SHED

FENCING & LANDSCAPING

DOMESTIC & INTERNAL

ARCHITECTURAL IRONMONGERY

WIRE FORMED PRODUCTS

PACKAGING OPTIONS

BESPOKE LASER CUTTING



Bespoke, made to order laser cut designs for your brand



Perfectly accurate detail on high quality steel

In-house design team to help bring your design to life



Can accommodate any shape or size up to 1.2m x 2.4m and up to 6mm thick material



FOR MORE INFORMATION VISIT US ONLINE: WWW.UKANDIN.COM



THE PERRY GROUP



GLOBAL MANUFACTURING & DISTRIBUTION

GLOBAL MANUFACTURING & DISTRIBUTION

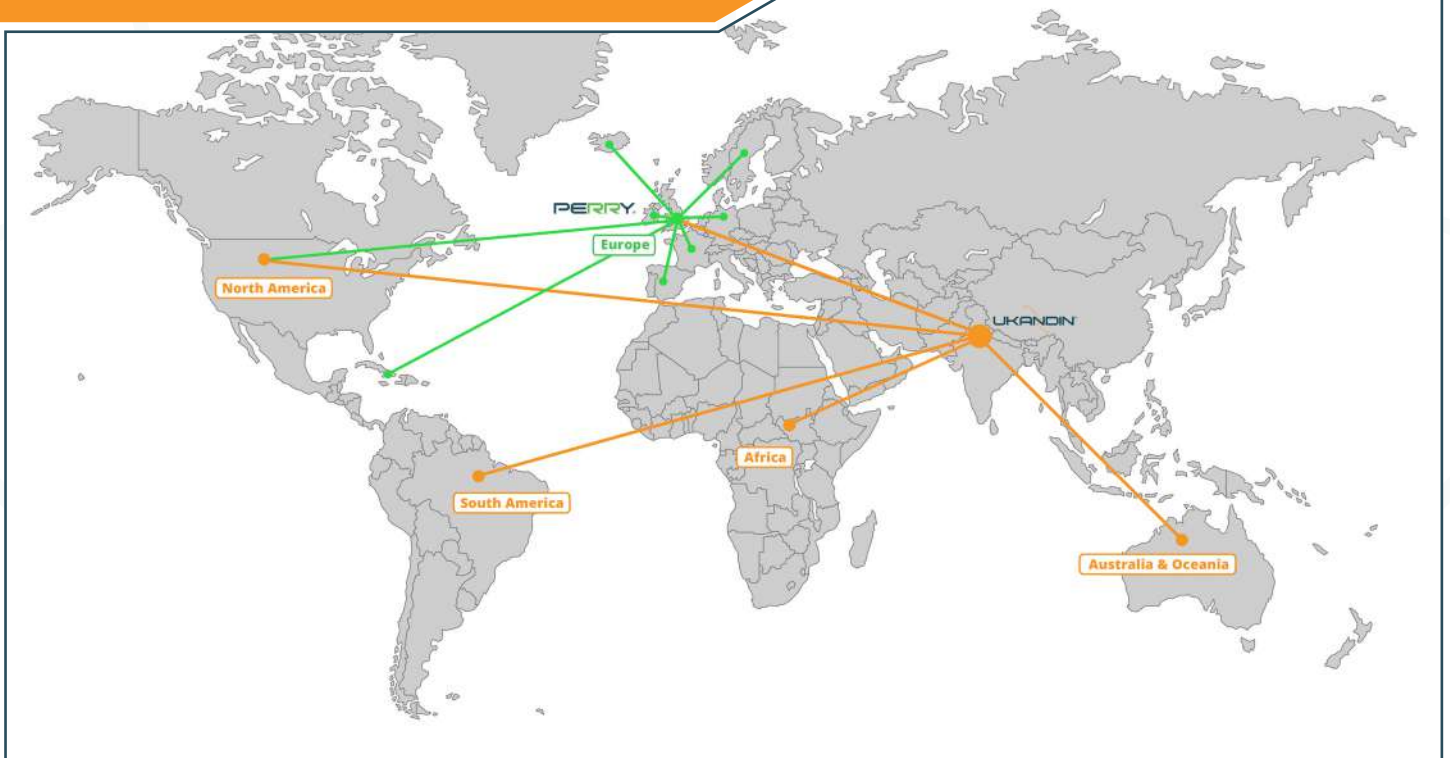

www.ukandin.com



sales@ukandin.com



UK Office: +44 (0)1384 319844
India Office: +91 981 004 5336



GLOBAL MANUFACTURING & DISTRIBUTION
OF HARDWARE & IRONMONGERY

UKANDIN International Private Limited

Greater Noida | Uttar Pradesh 201308 | India

Tel: +91 981 0045336 | Email: sales@ukandin.co.uk

www.ukandin.com



Sedex

QIMA
YOUR EYES IN THE SUPPLY CHAIN



UK Office (A. Perry Ltd)

Doulton Road | Cradley Heath | West Midlands | B64 5QW | United Kingdom

Tel: +44 (0)1384 319844

PART OF
THE PERRY GROUP